



Lichtdesign |
2018 |





ESTO Firmenzentrale • Velden • AUSTRIA



ESTO Lighting GmbH
9220 Lind ob Velden • Jessenigstraße 2 • AUSTRIA
Tel.: +43 (0)4274 3133-0 • Fax: +43 (0)4274 51359
www.esto.at • office@esto.at





762029-1 | Seite 04.12



762026-4 | Seite 04.12

BASIC

Einfach muss nicht langweilig heißen. Unser Basic Sortiment bietet preisgünstige Leuchten, die unabhängig vom Einsatzort zuverlässig Ihren Dienst leisten. Neueste, langlebige LED Technologie sorgt für niedrige Energiekosten und Zusatzfunktionen wie Farbwechsel und Dimmbarkeit.

Simple doesn't mean boring. Our Basic assortment offers lights at an attractive price, which are fulfilling their duty regardless of the area of use. State-of-the-art, long lasting LED technology ensures low energy bills and added functionality such as dimming and colour change.

Simple ne signifie pas ennuyeux. Notre entrée de gamme offre des luminaires à prix attractifs qui, quelque soit l'endroit dans votre maison, optimise l'éclairage demandé. Une technologie LED toujours à la pointe de la recherche, vous garantit des coûts d'utilisations faibles. Autres innovations importantes: les variations de couleur qui apportent des fonctions supplémentaires.

LAND HAUS

70135 | Seite 02.08



70159 | Seite 02.09

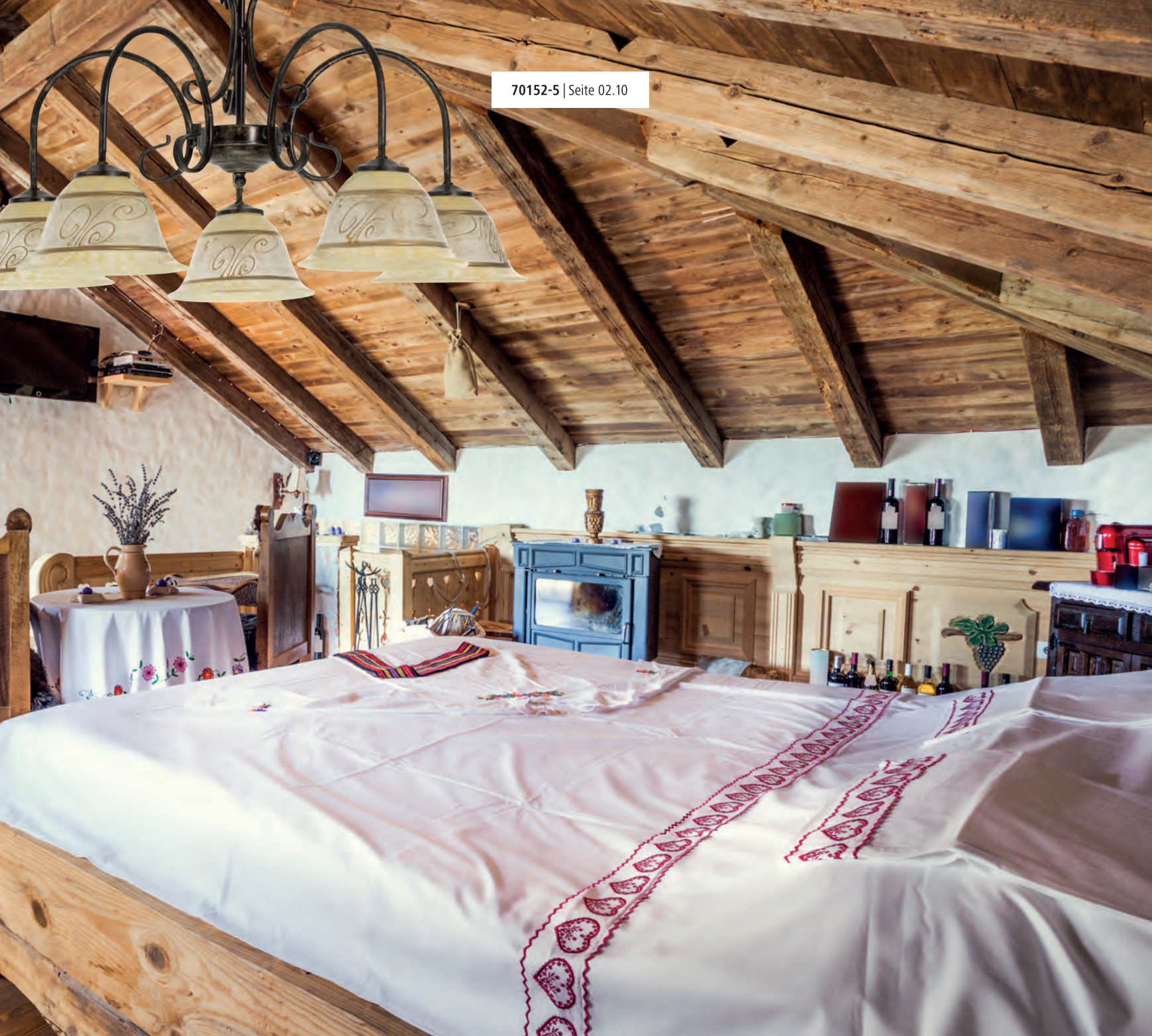

Natürliche Materialien, Maßarbeit und klassische Formen: Was könnte besser zum Landhausstil passen, als handbemalte Leuchten? Setzen sie Ihrem Wohnraum das I-Tüpfelchen auf! Unser Landhaussortiment wird in Europa hergestellt, und kann mit den neuesten, energiesparenden LED Leuchtmitteln kombiniert werden.

Natural materials, made-to-measure furniture and classic shapes: What could fit the Landhaus-style better than hand-painted luminaires? Add the final touch to your interior! Our Landhaus assortment is made in Europe, and can be combined with the latest energy saving LED bulbs.

Des matériaux naturels, des formes personnalisées et classiques: Qui pourrait mieux adapter le style rustique, telles que les lampes peintes à la main? Mettez dans votre salon la touche finale! Notre gamme villa est fabriquée en Europe, et peut être combinée avec les dernières ampoules LED à économie d'énergie.

15000 | Seite 01.10

EXOTIC

Sie möchten Urlaubsflair in Ihrem Zuhause?
Unsere Leuchten der Stilrichtung „Exotic“
verwandeln Ihr Zimmer in eine Oase der Ruhe.
Muster im Ethno-Stil, organische Materialien
und attraktive Schatteneffekte verzaubern nicht
nur Sie, sondern auch Ihre Gäste.

You want a holiday feel in your home? Our lights
in the “Exotic” style transform your room into an
oasis of peace and tranquility. Ethno-Style patterns,
organic materials and attractive shadow effects
put a spell on you and your guests.

Vous voulez une ambiance de vacances dans votre
maison? Nos luminaires de style transforment
votre chambre « exotique » en un havre de paix.
Des modèles dans un style ethnique, des matières
naturelles et des effets d’ombre attrayants vont
vous enchanter, mais aussi vos invités.



CLASSIC GLAMOUR

“Diamonds are a girl’s best friend”... Unsere Leuchten sind zwar nicht mit Edelsteinen ausgestattet, aber auch hochwertige Glas- und Acrylkristalle verleihen ihrer Wohnung einen Flair von Luxus. Ob Deckenleuchten mit Starlighteffekt oder Luster mit Kristallapplikationen – Unsere Classic Glamour Serie bringt ihr Heim zum Glitzern.

“Diamonds are a girl’s best friend”... Our lights are not equipped with precious stones, but classy crystals made of glass and acrylic lend your home a touch of luxury. Whether it’s ceiling lamps with starlight effects or chandeliers with crystal decorations – our Classic Glamour line adds sparkle to your home.

“Les diamants sont les meilleurs amis d’une femme”... Nos luminaires ne sont pas équipés de pierres précieuses, mais avec des verres de haute qualité et les cristaux acryliques donnent à votre intérieur une touche de luxe. Que ce soit plafonniers avec des effets de ciel étoilé ou lustre avec des cristaux – Notre série classique apporte un éclat glamour pour la maison.

20507 | Seite 06.29





70020-7 | Seite 02.04



VINTAGE

18025 | Seite 01.06



Ein Loft in einer hippen Ecke Ihrer Stadt?
Oder doch eine Villa am Stadtrand? Wo auch immer für Sie ‚Zuhause‘ ist, mit Leuchten im Vintage Stil liegen sie voll im Trend. Die matten Oberflächen, gepaart mit industriell angehauchtem Design passen perfekt zu Filament Leuchtmitteln – die den gewohnten Look von konventionellen Glühbirnen mit der modernsten LED Technik verbinden.

A loft in a hip quarter of your city? Or rather a house in the suburbs? Wherever ‘home’ is for you, with Vintage style lights, it will be ‘en vogue’. Matt surfaces, paired with industrially inspired design are a perfect match for filament lightsources – combining the acquainted look of conventional incandescent bulbs with state-of-the-art LED technology.

Un loft dans un quartier de votre ville?
Ou plutôt une maison en banlieue? Partout où la «maison» est pour vous, avec des luminaires de style Vintage, elle sera «en vogue». Les surfaces mates, associées à un design inspiré de l’industrie, sont une combinaison parfaite pour les ampoules filaments filaments - combinant l’aspect familier des ampoules à incandescence conventionnelles et la technologie LED à la pointe de la technologie.

18105 | Seite 01.04





15078 | Seite 01.09

MODERN DESIGN

Reduzierte Formen, die trotzdem ausdrucksvoll sind. Hochqualitative Materialien, die sich an das Ambiente anpassen oder einen interessanten Kontrast hinzufügen. Modern Design setzt Akzente, die den Wohnraum aufhellen!

Reduced shapes, which are still expressive. High quality Materials, which either fit into the surroundings or add interesting contrast. Modern Design accentuates and brightens up your home! Designer, oder Zeitgeist zu tun. Vielmehr geht es darum die Anforderungen, die an ein Produkt gestellt werden zu erkennen.

Des formes réduites qui ont un style expressif. Des matériaux de haute qualité, qui s'adaptent parfaitement aux environnements ou ajoutent un contraste intéressant. Le design moderne illumine le salon!



Design und Produktentwicklung

Ein flüchtiger Augenblick der Inspiration ist Ursprung der besten Ideen. Die Entwicklung eines Designs hat nichts mit dem Geschmack der beteiligten Designer, oder Zeitgeist zu tun. Vielmehr geht es darum die Anforderungen, die an ein Produkt gestellt werden zu erkennen und darauf basierend Charakter und Leistung zu visualisieren. Nicht mehr - und vor allem nicht weniger.

Design geht weit über schöne Formgebung hinaus. Konzeptionelles Denken und strategische Interaktion auf den verschiedensten Bereichen bilden die Basis erfolgreicher Gestaltung. Ist die grundlegende Idee einmal gefunden, wird ihre Kernessenz weiter entwickelt und optimiert. Ästhetik aber auch Wirtschaftlichkeit und konstruktionstechnische Aspekte sind die maßgebenden Größen unserer Produktgestaltung.

Design needs to be fresh, not over-worked, or over-used. A single moment of inspiration is giving birth to best designs. Neither the designer's taste nor the actual trend is controlling the product development. The demands placed on a product must be detected and solved. Not more, but particularly not less.

Good design is more than only aesthetic shaping. Conceptional and strategic acting is the base of every successful design. Once an idea is created, the essential content will get optimized - by considering aesthetics and shapeliness, as well as aspects of manufacturing and cost efficiency - to the final pro-



Produktion und Qualitätssicherung

ESTO LIGHTING hat sich im gesamteuropäischen Raum als qualitativ hochwertiger Leuchtenproduzent etabliert. 44 Jahre Erfahrung am Leuchtenmarkt sowie eine eigene Fertigungsstätte ermöglichen es uns preiswerte Qualitätsware zu erzeugen. In der ESTO Leuchtenmanufaktur erfolgt die Serienfertigung unserer Produktpalette. Zusätzlich kooperieren wir in vielen Projekten mit externen Spezialisten die zum Teil ausschließlich für die ESTO LIGHTING produzieren. All unsere Fertigungslinien unterliegen hundertprozentiger Qualitätskontrollen. Im firmeneigenen Prüfzentrum wird unsere Ware nach aktuellen Normen getestet um unseren Qualitätsanspruch sicherzustellen. Diese Infrastruktur macht die ESTO Lighting zu einem der kompetentesten Leuchtenproduzenten im Alpe-Adria Raum.

ESTO LIGHTING is known as a high-quality lighting manufacturer. 44 years of presence in the lighting sector and a proper production facility enable us to produce premium quality products at a low price. The volume production of our articles is done in the ESTO LIGHTING factory. In some projects we additionally cooperate with external specialists, who produce exclusively for us. Our products are subjected to continuous control at every stage of production. This infrastructure make ESTO LIGHTING to one of the most competent lighting manufacturers in the Alpe-Adria region.



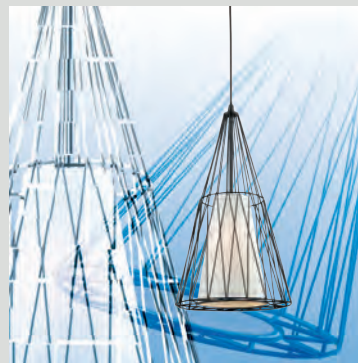

Pendelleuchten
pendant lights
suspensions

01



Klassik
classics
classic

02



**Wand- und
Deckenleuchten**
wall & ceiling lights
appliques et plafonniers

03

Index

ESTO Lighting GmbH
9220 Lind ob Velden, Jessenigstraße 2, AUSTRIA
Tel.: +43 (0)4274 3133-0, Fax: +43 (0)4274 51359
www.esto.at, office@esto.at



Spotleuchten
spotlights
spots

04



Außenleuchten
outdoor lights
luminaires extérieurs

07

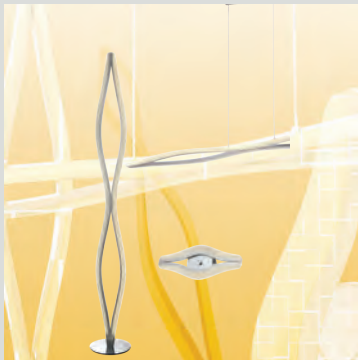

Leuchtenfamilien
lamp series
série de lamp

05



Technisches Licht
technical lights
lumière technique

08



Tisch-/Stehleuchten
table-/floor lamps
lampes à poser et
lampadaires

06



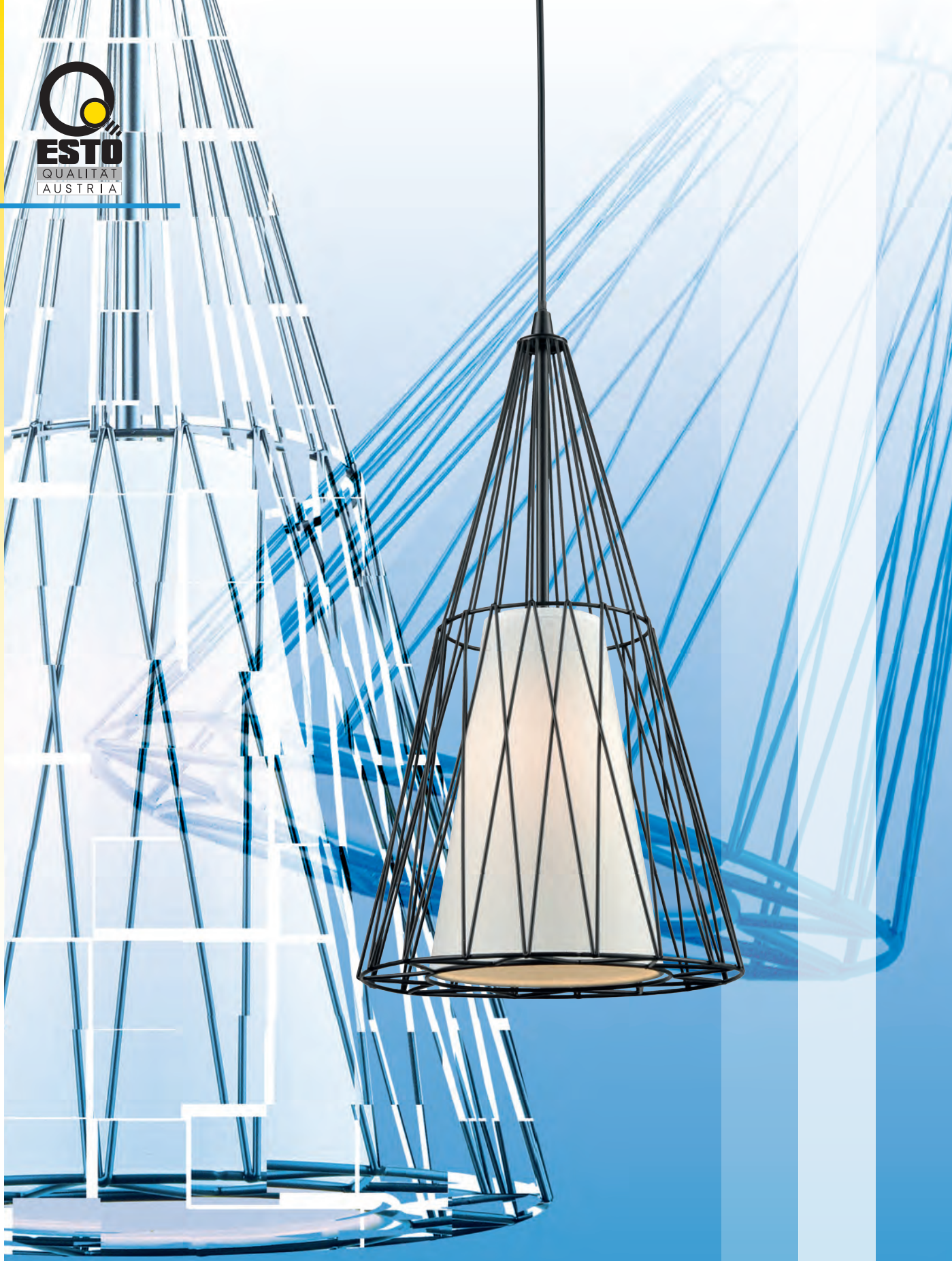

01

Pendelleuchten

pendant lights
suspensions

COOKE	03
NATALIA	04
LILLY	05
WIRE	06
BURL	07
SWIRL	08
OLIVE	09
ORIENT	10
AMADO	11
CARME	12
DIAMOND	13
JARON	15
STELLAR	17
COSMO	19
BIRDY	20
PERLA	21
BALLINA	22
SCALY	23
ACRYLIC	23
KEVIN	24
MILENA	25
FANTASIA	29
MILENA	31
HELSINKI	32

Metall • Kunststoff
metal • plastic
métal • plastique

40W  E27 230V

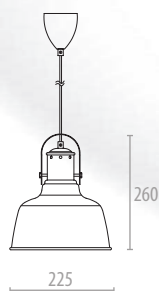

18102
Ø 225 x 260 • ↓ 1200 • VE/PU: 2
1 x 40 W • E27 • 230V

A++ bis E



9 100334811405521

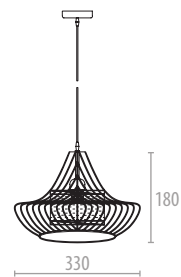

18104
Ø 330 x 180 • ↓ 1200 • VE/PU: 2
1 x 40 W • E27 • 230V

A++ bis E



9 10033481140590

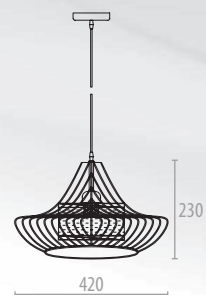

18105
Ø 420 x 230 • ↓ 1200 • VE/PU: 2
1 x 40 W • E27 • 230V

A++ bis E



9 10033481140606



18102



18104



18105



18020



18021

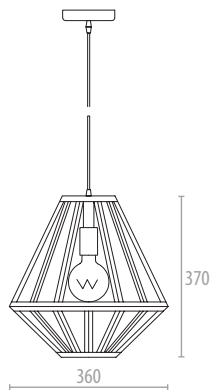

18020
Ø 360 x 370 • ↓ 1200 • VE/PU: 1
1 x 40 W • E27 • 230V

Metall
metal
métal

A++ bis E



9 003348 140729

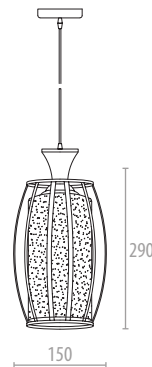

18021
Ø 150 x 290 • ↓ 1200 • VE/PU: 4
1 x 40 W • E27 • 230V

Metall • Glas
metal • glass
métal • verre

A++ bis E



9 003348 140736



18024



18025

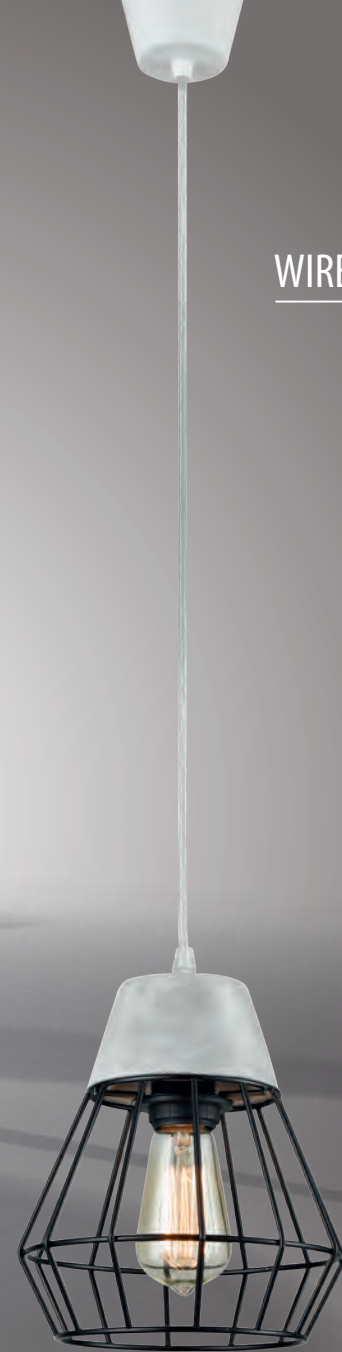

18026

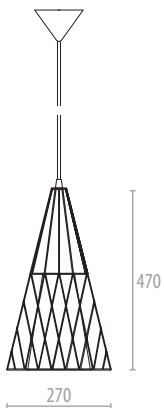

18024

Ø 270 x 470 • ↓ 1200 • VE/PU: 1
1 x 40 W • E27 • 230V

Metall • Textil
metal • textil
métal • textile

A++ bis E



9 003348 141184

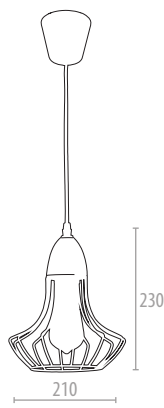

18025

Ø 210 x 230 • ↓ 1200 • VE/PU: 6
1 x 40 W • E27 • 230V

Metall • Beton
metal • concrete
métal • béton

A++ bis E



9 003348 141191

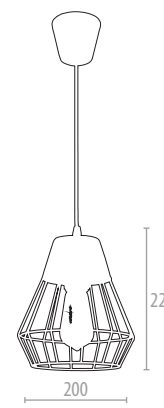

18026

Ø 200 x 220 • ↓ 1200 • VE/PU: 6
1 x 40 W • E27 • 230V

Metall • Beton
metal • concrete
métal • béton

A++ bis E



9 003348 141207



Holz • Metall • Kunststoff
wood • metal • plastic
bois • métal • plastique

40W  E27 230V

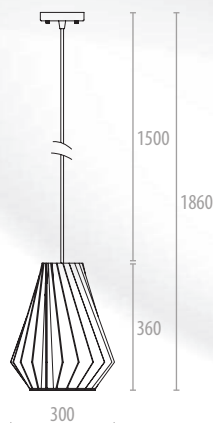

15076

Ø 300 x 360 • ↓ 1860 • VE/PU: 1
1 x 40 W • E27 • 230V

A++ bis E



9 10033481143119

SWIRL

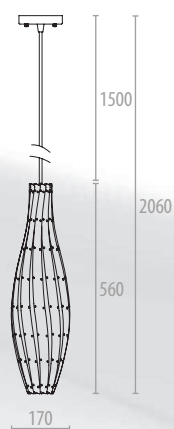

15068

Ø 170 x 560 • ↓ 2060 • VE/PU: 1
1 x 40 W • E27 • 230V

A++ bis E



9 10033481143072

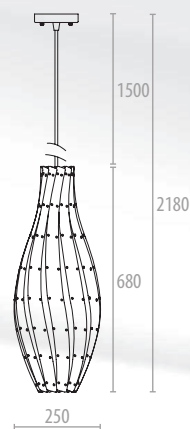

15069

Ø 250 x 680 • ↓ 2180 • VE/PU: 1
1 x 40 W • E27 • 230V

A++ bis E



9 10033481143089



15076



15068



15069



15078



Holz • Kunststoff
wood • plastic
bois • plastique

40W  E27 230V

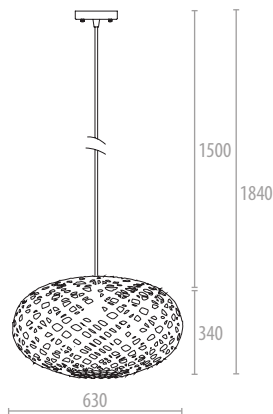

15078

Ø 630 x 340 • ↓ 1840 • VE/PU: 1
1 x 40 W • E27 • 230V

A++ bis E





17054



15000



20000

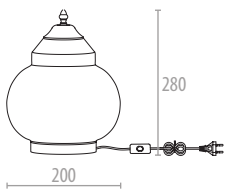

20000
Ø 200 • ↑ 280 • VE/PU: 4
1 x 60 W • E27 • 230V

A++ bis E

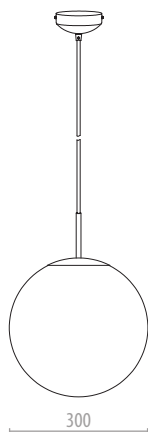

17054
Ø 300 • ↓ 1200 • VE/PU: 1
1 x 60 W • E27 • 230V

A++ bis E

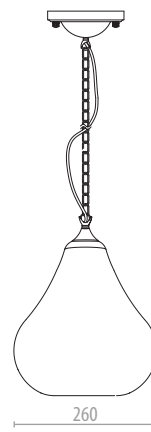

15000
Ø 260 x 295 • ↓ 1100 • VE/PU: 1
1 x 40 W • E27 • 230V

A++ bis E



Stahl gebürstet • Chrom
metal brushed • chrome
métal brossé • chrome

E27 | 230V

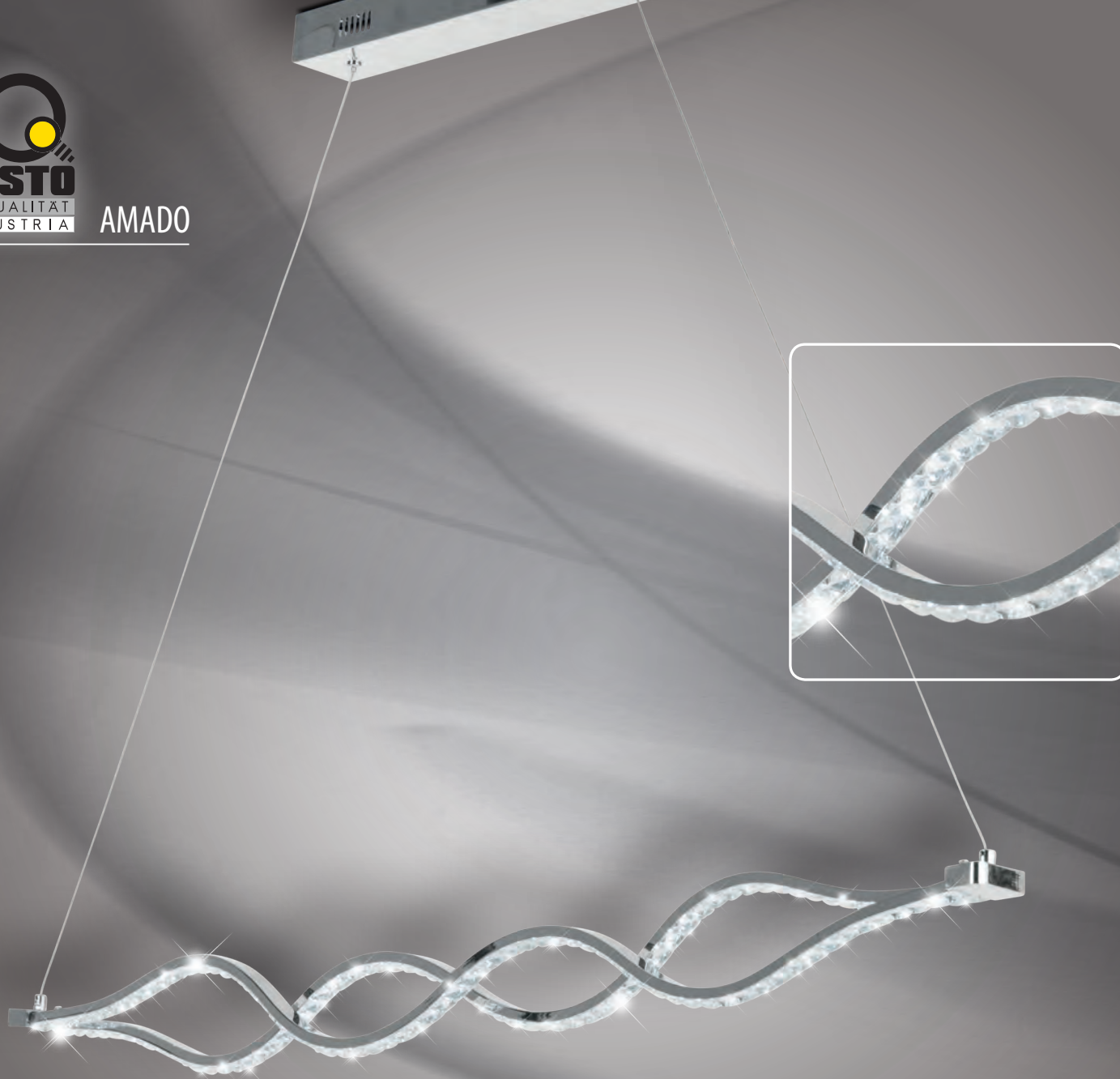

711005

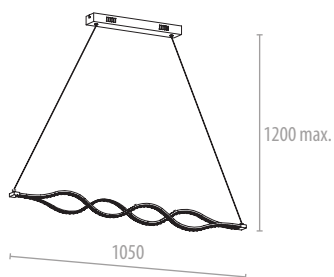

Chrom • Acryl
chrome • acrylic
chrome • acrylique

incl. SMD LED

711005

1050 x 70 - ↑ 1200 - VE/PU: 4
incl. 1 x 18 W - SMD-LED - 1440lm - 4000K - A

A 1440lm - 18 kWh/1000h - 230V



9 1003348 114484 0



„CRYSTAL PIPE“
Stehleuchte • floor
lamp • lampadaire



6.38



710060

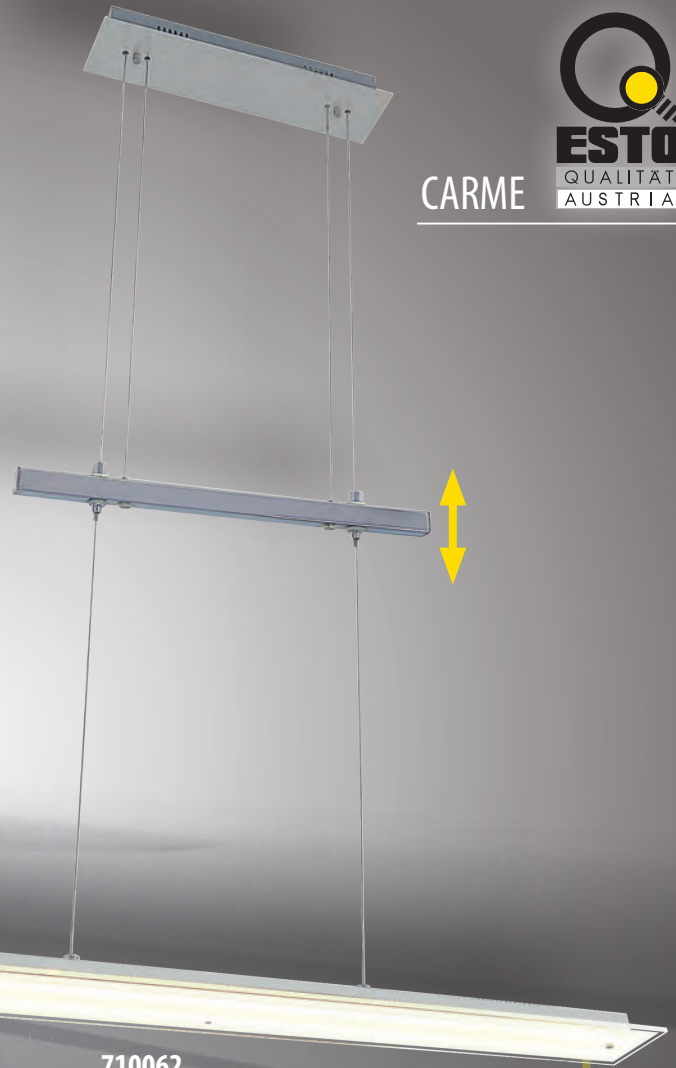

710062

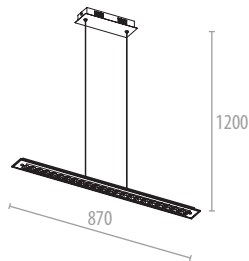
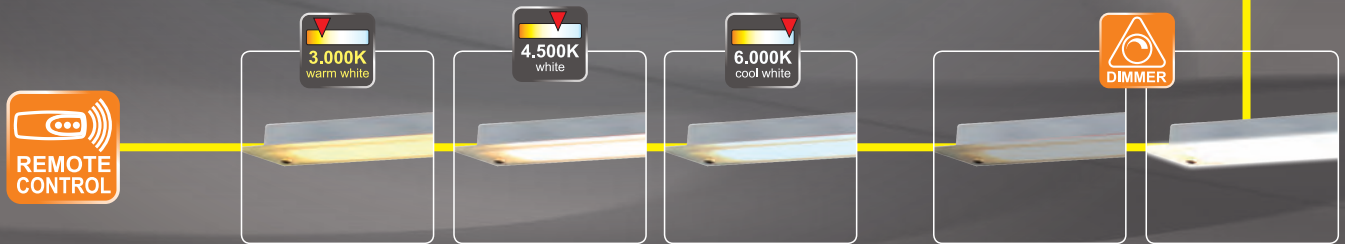

710060
870 x 90 • ↓ 1200 • VE/PU: 4
incl. 1 x 24 W • SMD LED • 1920lm • 3000K • A
A → 1920lm • 24 kWh/1000h • 230V



9 400334 811421 12

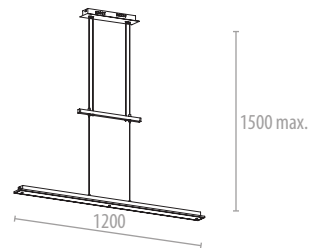

710062
1200 x 75 • ↓ 1500 • VE/PU: 4
incl. 1 x 30 W • SMD LED • 2400lm • 3000K/4500K/6000K • A
A → 2400lm • 30 kWh/1000h • 230V



9 400334 811421 36



Chrom • Glas
chrome • glass
chrome • verre

incl. SMD LED

Chrom • Glas
chrome • glass
chrome • verre

incl. SMD LED

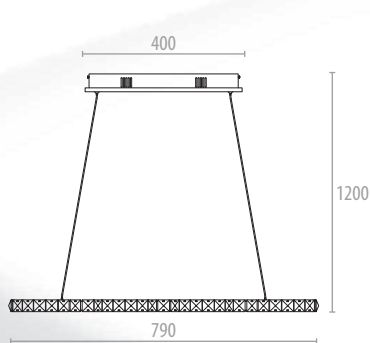

780105

↔ 790 x 200 • ↓ 1200 • VE/PU: 3
incl. 1 x 20 W • SMD-LED • 1700lm • 4000K • A+

A+ 1700lm • 20 kWh/1000h • 230V



9 003348 112375

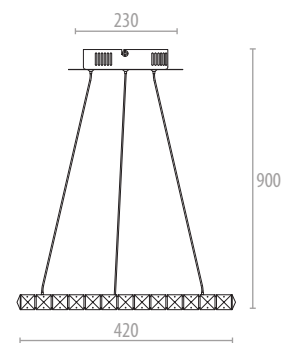

780106

Ø 420 • ↓ 900 • VE/PU: 4
incl. 1 x 12 W • SMD-LED • 1020lm • 4000K • A+

A+ 1020lm • 12 kWh/1000h • 230V



9 003348 112399



780105



780106

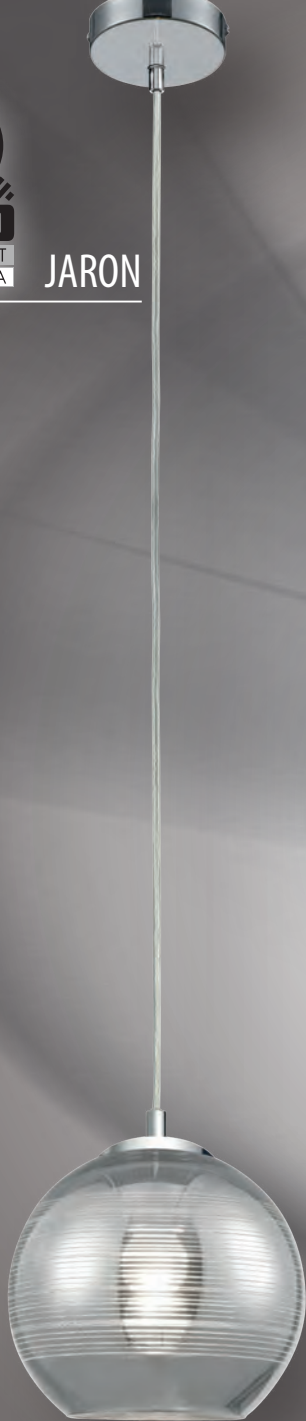

16186-1



16188-1



16185-1

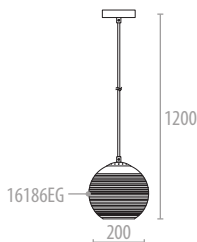

16186-1

Ø 200 • ↓ 1200 • VE/PU: 4
1 x 40 W • E27 • 230V

A++ bis E

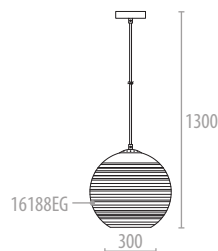

16188-1

Ø 300 • ↓ 1300 • VE/PU: 2
1 x 40 W • E27 • 230V

A++ bis E

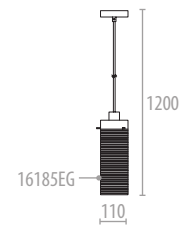

16185-1

Ø 110 • ↓ 1200 • VE/PU: 6
1 x 40 W • E27 • 230V

A++ bis E



Chrom • Glas
chrome • glass
chrome • verre

40W - E27

230V



16185-3

16187

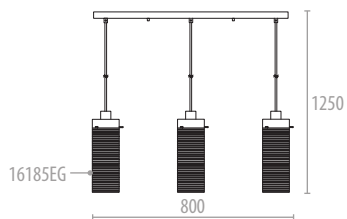

16185-3

↔ 800 • ↓ 1250 • VE/PU: 2
3 x 40 W • E27 • 230V

A++ bis E



9 003 348 158 069

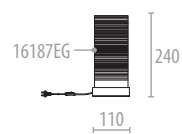

16187

Ø 110 • ↑ 240 • VE/PU: 6
1 x 40 W • E27 • 230V

A++ bis E



9 003 348 155 167



Chrom • Glas
chrome • glass
chrome • verre

40W - E27 | 230V



16145-1



16147

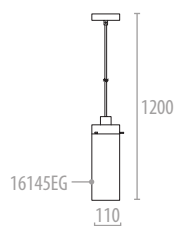

16145-1

Ø 110 • ↓ 1200 • VE/PU: 6
1 x 60 W • E27 • 230V

A++ bis E



9 003 348 1 565 08

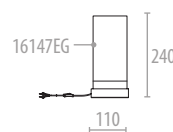

16147

Ø 110 • ↓ 240 • VE/PU: 6
1 x 60 W • E27 • 230V

A++ bis E



9 003 348 1 565 39

Chrom • Glas
chrome • glass
chrome • verre

60W - E27 | 230V



16145-3

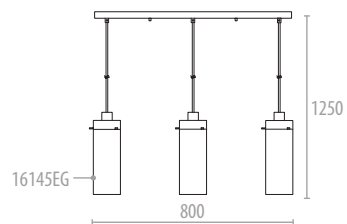

16145-3

↔ 800 • ↓ 1250 • VE/PU: 2
3 x 60 W • E27 • 230V

A++ bis E



Chrom • Glas
chrome • glass
chrome • verre

60W - E27	230V
-----------	------



16152-1



16151



16152-3

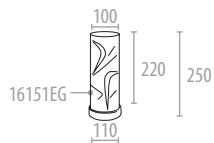

16151
Ø 110, ↑ 250 - VE/PU: 6
1 x 60 W - E27 - 230V

A++ bis E



9 003348 189097 6

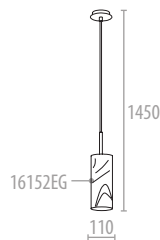

16152-1
Ø 110, ↓ 1450 - VE/PU: 18
1 x 60 W - E27 - 230V

A++ bis E



9 003348 189098 3

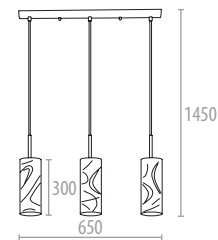

16152-3
↔ 650, ↓ 1450 - VE/PU: 3
3 x 60 W - E27 - 230V

A++ bis E



9 003348 189160 7

Chrom • Glas
chrome • glass
chrome • verre

60W E27 230V



16166-3



16165



16165
Ø 300 - VE/PU: 3
1 x 60 W - E27 - 230V

A++ bis E



9 100334 818951 55

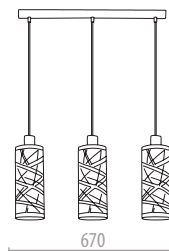

16166-3
↔ 670 - VE/PU: 3
3 x 60 W - E27 - 230V

A++ bis E



9 100334 818951 79



Chrom • Kunststoff
chrome • plastic
chrome • plastique

60W  E27 | 230V



17020



17019



17020
Ø 400 - VE/PU: 1
1 x 60 W - E27 - 230V

A++ bis E



9 003348 189118 8



17019
Ø 300 - VE/PU: 1
1 x 60 W - E27 - 230V

A++ bis E



9 003348 189117 1

Chrom • Kunststoff
chrome • plastic
chrome • plastique

60W E27 230V



991430



991431

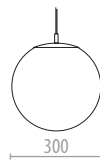

991430
Ø 300 - VE/PU: 1
1 x 60 W - E27 - 230V

A++ bis E

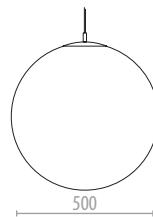

991431
Ø 500 - VE/PU: 1
1 x 60 W - E27 - 230V

A++ bis E



Naturfaser • Metall
natural fibre • metal
fibre naturellez • métal

60W  E27 230V



15034



914001



914005



SCALY

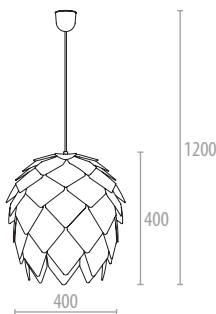

15034
Ø 400 • VE/PU: 1
1 x 40 W • E27 • 230V

A++ bis E



Kunststoff
plastic
plastique

40W E27 230V



ACRYLIC



914001
Ø 180 • VE/PU: 12
1 x 60 W • E27 • 230V

A++ bis E

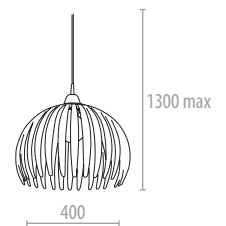

914005
Ø 400 • VE/PU: 6
1 x 60 W • E27 • 230V

A++ bis E



Metall • Kunststoff • Acryl
metal • plastic • acrylic
métal • plastique • acrylique

60W E27 230V



914092



914093

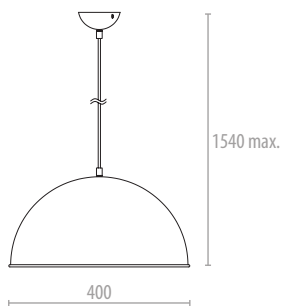

914092 ●
Ø 400 - VE/PU: 4
1 x 60 W - E27 - 230V

A++ bis E



9 1003348 106497

914093 ○
Ø 400 - VE/PU: 4
1 x 60 W - E27 - 230V

A++ bis E



9 1003348 106503



Metall lackiert • Textil
metal coated • textile
métal laqué • textile

60W E27 230V



15671



15672



15679



15666



15667

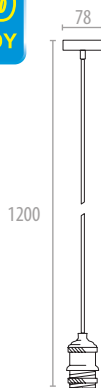

15671 ●
↓ 1200 - VE/PU: 5
1 x 60 W - E27
Messing antik • Textil
old brass • fabrics
laiton fumé • textile
A++ bis E > 230V



9 003348 111200

15672 ●
↓ 1200 - VE/PU: 5
1 x 60 W - E27
Messing antik • Textil
old brass • fabrics
laiton fumé • textile
A++ bis E > 230V



9 003348 158267

15679 ●
↓ 1200 - VE/PU: 5
1 x 60 W - E27
Kupfer • Textil
copper • fabrics
cuivre • textile
A++ bis E > 230V



9 003348 158335

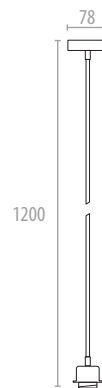

15666 ●
↓ 1200 - VE/PU: 5
1 x 60 W - E27
Stahl gebürstet • Textil
metal brushed • fabrics
mßetal brossé • textile
A++ bis E > 230V



9 003348 111231

15667 ●
↓ 1200 - VE/PU: 5
1 x 60 W - E27
Stahl gebürstet • Textil
metal brushed • fabrics
mßetal brossé • textile
A++ bis E > 230V



9 003348 111248



15689



15688



15687



15685



15686

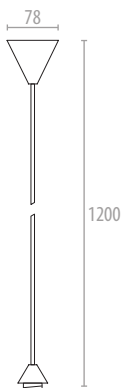

15685 ●
↓ 1200 - VE/PU: 5
1 x 60 W - E27
Kunststoff • Textil
plastic • fabrics
plastique • textile
A++ bis E 230V



15686 ●
↓ 1200 - VE/PU: 5
1 x 60 W - E27
Kunststoff • Textil
plastic • fabrics
plastique • textile
A++ bis E 230V



15687 ●
↓ 1200 - VE/PU: 5
1 x 60 W - E27
Kunststoff • Textil
plastic • fabrics
plastique • textile
A++ bis E 230V



15688 ●
↓ 1200 - VE/PU: 5
1 x 60 W - E27
Kunststoff • Textil
plastic • fabrics
plastique • textile
A++ bis E 230V



15689 ●
↓ 1200 - VE/PU: 5
1 x 60 W - E27
Kunststoff • Textil
plastic • fabrics
plastique • textile
A++ bis E 230V





15666



15685



15667



15686



15671



15687



15672



15688



15679



15689



173001 
 Ø 80 · ↓ 1100 · VE/PU: 50
 1 x 60 W · E27 · 230V
 Kunststoff
 plastic
 plastique



9 003348 196054 9

173008 
 Ø 80 · ↓ 1100 · VE/PU: 50
 1 x 60 W · E27 · 230V
 Kunststoff
 plastic
 plastique



9 003348 184532 1



173001



173008

FANTASIA



991478



15983

FANTASIA

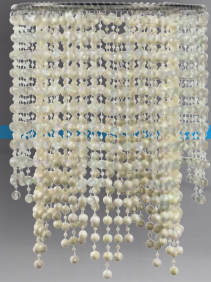

15984

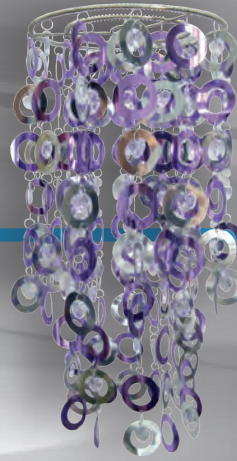

991469



15982

MILENA



15605

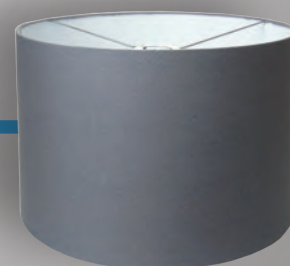

15606

HELSINKI

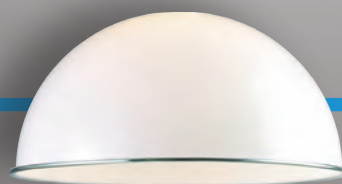

991408



991409



15982

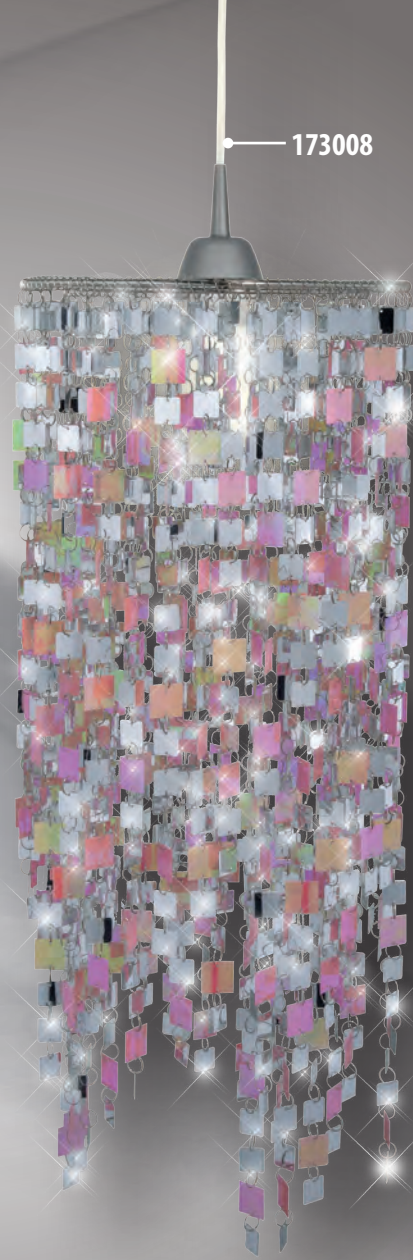

15983

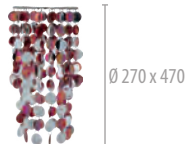

15982
Ø 270 • ↓ 470 • VE/PU: 10
1 x 60 W • E27 • 230V
Chrom • Kunststoff
chrome • plastic
chrome • plastique



15983
Ø 230 • ↓ 630 • VE/PU: 10
1 x 60 W • E27 • 230V
Chrom • Kunststoff
chrome • plastic
chrome • plastique



60W E27 230V



991469



991478



15984



991469

Ø 270 · ↓ 540 · VE/PU: 10
1 x 60 W · E27 · 230V

Chrom · Kunststoff
chrome · plastic
chrome · plastique



9 003348 1887365



991478

Ø 230 · ↓ 630 · VE/PU: 10
1 x 60 W · E27 · 230V

Chrom · Kunststoff
chrome · plastic
chrome · plastique



9 003348 1887358



15984

Ø 230 · ↓ 300 · VE/PU: 10
1 x 60 W · E27 · 230V

Chrom · Kunststoff
chrome · plastic
chrome · plastique



9 003348 112542

60W E27 230V

173008



15605



15606

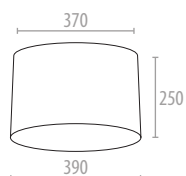

15605 ●
Ø 390/370 • ↑250 • VE/PU: 5
für max. 60W, E27 • 230V
Metall lackiert • Textil
painted metal • fabrics
métal verni • textile



15606 ●
Ø 390/370 • ↑250 • VE/PU: 5
für max. 60W, E27 • 230V
Metall lackiert • Textil
painted metal • fabrics
métal verni • textile



Metall lackiert • Textil
painted metal • fabrics
métal verni • textile

60W E27 230V



991408



991409

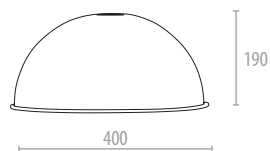

991408 ●
Ø 400 · ↓ 190 · VE/PU: 10
1 x 60 W · E27 · 230V

A++ bis E



9 003348 884913

991409 ●
Ø 400 · ↓ 190 · VE/PU: 10
1 x 60 W · E27 · 230V

A++ bis E



9 003348 848694

Kunststoff
plastic
plastique

60W  E27 230V



02

Klassik
classics
classic

THERESA	03
NIZZA	05
"MESSINA VANILIA"	07
"MESSINA VANILIA"	09
KAIRO	11
FERRARA	13
MESSINA	15
VENEZIA	17
VENEZIA	19
ROMANTICA	22
VIOLA	23
VENETA	24
CINDY	24
ROMANTICA	25
ROMANTICA	27
CLASSIK	29
CLASSIK	31
PROVENCE ECO	32



70020-5



Chrom • Glas
chrome • glass
chrome • verre

40W  E14 230V

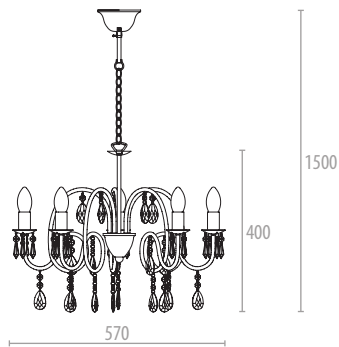

70020-5
Ø 570 • ↓ 1500 • VE/PU: 1
5 x 40 W • E14 • 230V

A++ bis E





70020-7

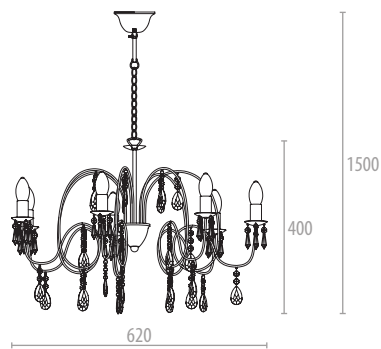
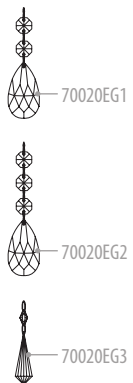

70020-7
Ø 620 • ↓ 1500 • VE/PU: 1
7 x 40 W • E14 • 230V

A++ bis E



Chrom • Glas
chrome • glass
chrome • verre

40W  E14 230V



70100



70101



Metall • Glas
metal • glass
métal • verre

60W - E27 | 230V

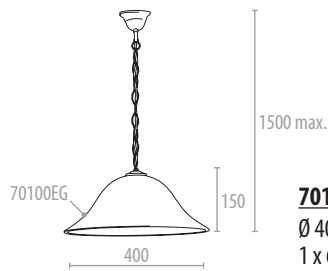

70100
Ø 400 - VE/PU: 1
1 x 60 W - E27 - 230V

A++ bis E



9 003348 1142204

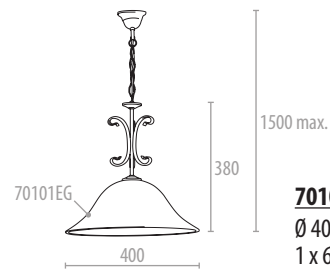

70101
Ø 400 - VE/PU: 1
1 x 60 W - E27 - 230V

A++ bis E



9 003348 1142211



70102-5

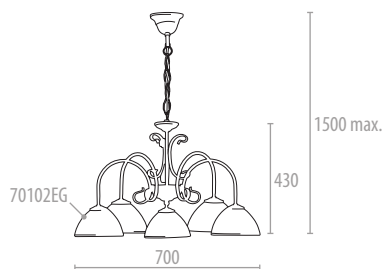

70102-5
Ø 700 - VE/PU: 1
5 x 40 W - E14 - 230V

A++ bis E



9 10033481142228



Metall • Glas
metal • glass
métal • verre

60W - E27	230V
-----------	------



70133



70132



70130



Metall • Glas
metal • glass
métal • verre

60W - E27 | 230V



1500 max.

70130EG

70130
Ø 400 • VE/PU: 1
1 x 60 W • E27 • 230V

A++ bis E



9 003348 142426



1500 max.

70132EG

70132
Ø 250 • VE/PU: 1
1 x 60 W • E27 • 230V

A++ bis E



9 003348 142433



1500 max.

70133EG

70133
Ø 400 • VE/PU: 1
1 x 60 W • E27 • 230V

A++ bis E



9 003348 142440



70139



70138



70137



70135

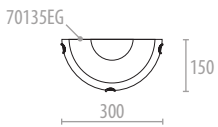

70135

↔ 300 • ↑ 150 • VE/PU: 1
1 x 60 W • E27 • 230V

A++ bis E



9 003348 142457

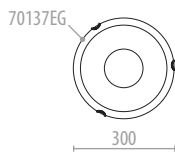

70137

Ø 300 • VE/PU: 1
1 x 60 W • E27 • 230V

A++ bis E



9 003348 142464

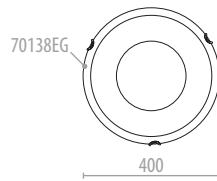

70138

Ø 400 • VE/PU: 1
2 x 60 W • E27 • 230V

A++ bis E



9 003348 142471

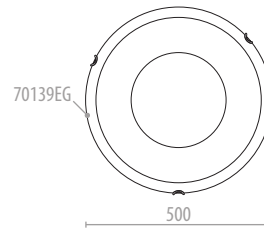

70139

Ø 500 • VE/PU: 1
3 x 60 W • E27 • 230V

A++ bis E



9 003348 142488



Metall • Glas
metal • glass
métal • verre

60W - E27 | 230V



70151

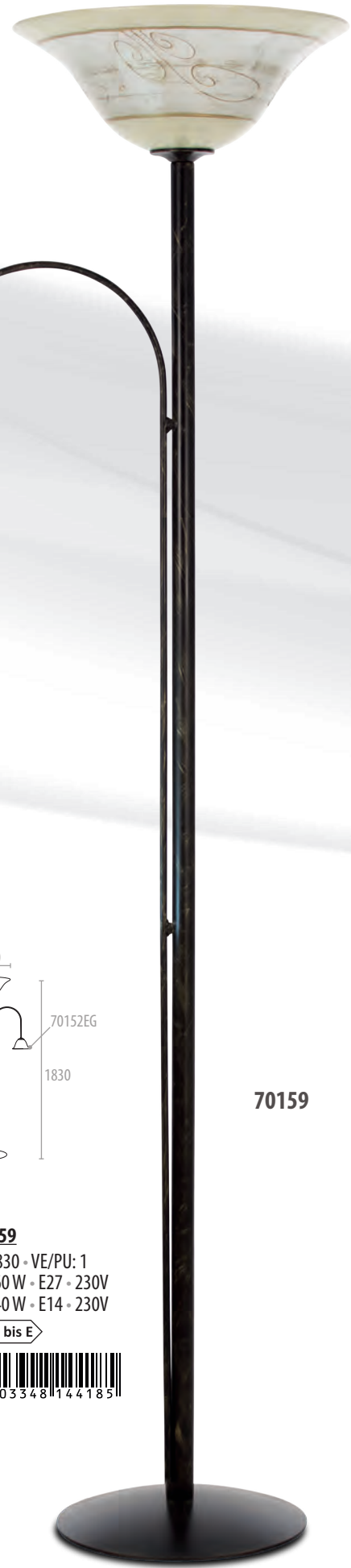

70159

Metall • Glas
metal • glass
métal • verre

60W - E27 230V

40W - E14 230V

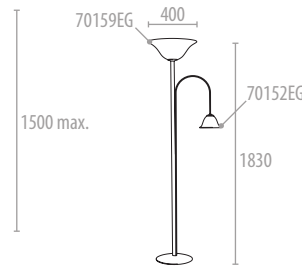
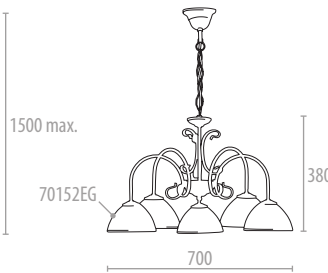
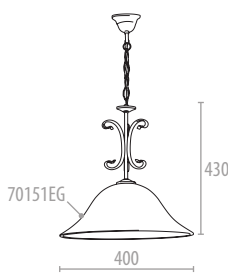

70151

Ø 400 - VE/PU: 1
1 x 60 W - E27 - 230V

A++ bis E



70152-5

Ø 700 - VE/PU: 1
5 x 40 W - E14 - 230V

A++ bis E



70159

↑ 1830 - VE/PU: 1
1 x 60 W - E27 - 230V
1 x 40 W - E14 - 230V

A++ bis E





70152-5



70112



70110



Metall • Glas
metal • glass
métal • verre

60W - E27 | 230V

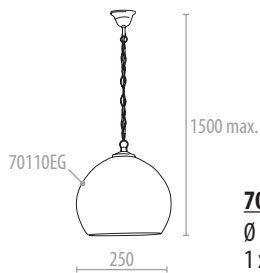

70112
Ø 250 • VE/PU: 1
1 x 60 W • E27 • 230V

A++ bis E



9 1003348 1142273

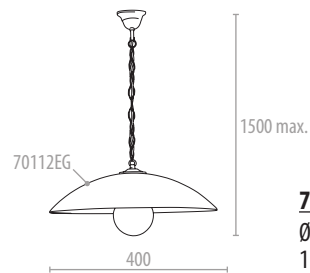

70110
Ø 400 • VE/PU: 1
1 x 60 W • E27 • 230V

A++ bis E



9 1003348 1142259



70119



70118



70117



70115

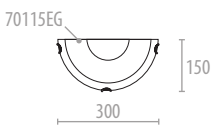

70115

↔ 300 • ↑ 150 • VE/PU: 1
1 x 60 W • E27 • 230V

A++ bis E



9 003348 142297

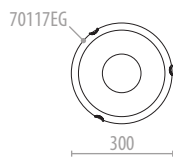

70117

Ø 300 • VE/PU: 1
1 x 60 W • E27 • 230V

A++ bis E



9 003348 1142303

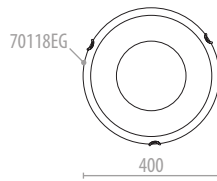

70118

Ø 400 • VE/PU: 1
2 x 60 W • E27 • 230V

A++ bis E



9 003348 142310

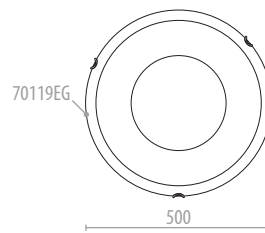

70119

Ø 500 • VE/PU: 1
3 x 60 W • E27 • 230V

A++ bis E



9 003348 1142327



Metall • Glas
metal • glass
métal • verre

60W - E27 | 230V

**MADE IN
EUROPE**

*Hand
Made*

**LED
READY**

60W  E27 230V



70121

1500 max. Ø 400 - VE/PU: 1
1 x 60 W - E27 - 230V

A++ bis E



70127

Ø 300 - VE/PU: 1
1 x 60 W - E27 - 230V

A++ bis E

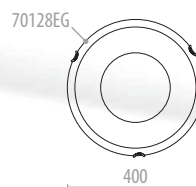

70128

Ø 400 - VE/PU: 1
2 x 60 W - E27 - 230V

A++ bis E



70121



70128

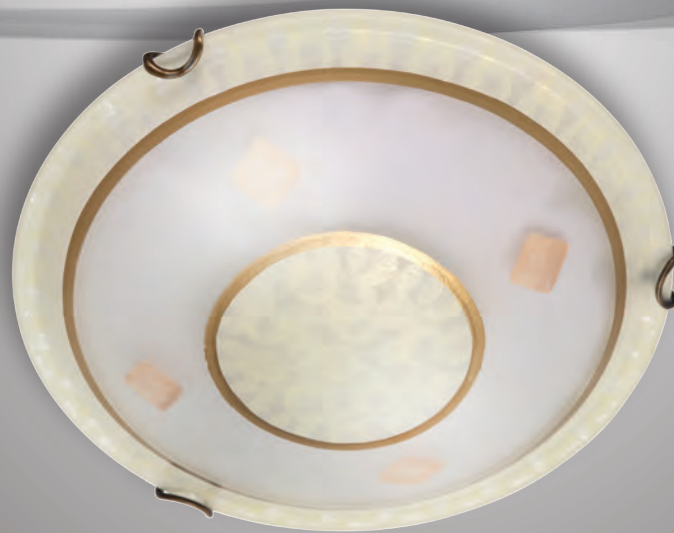

70127



70142



70146

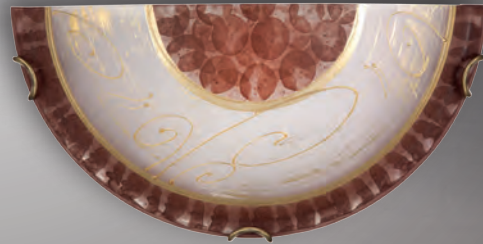

70145

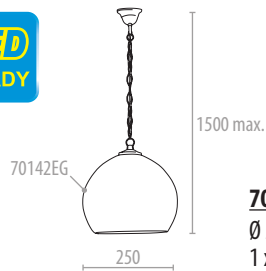

70142
Ø 250 - VE/PU: 1
1 x 60 W - E27 - 230V

A++ bis E

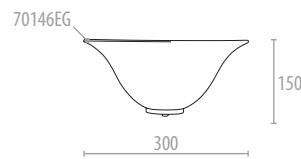

70146
↔ 300 - ↑ 200 - VE/PU: 1
1 x 60 W - E27 - 230V

A++ bis E

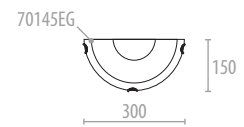

70145
↔ 300 - ↑ 150 - VE/PU: 1
1 x 60 W - E27 - 230V

A++ bis E



Metall • Glas
metal • glass
métal • verre

60W - E27 | 230V

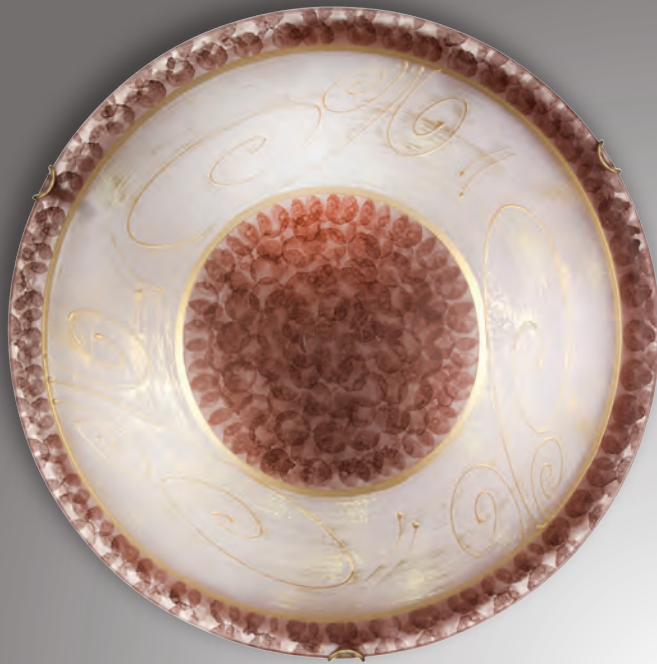

70149



70148



70147

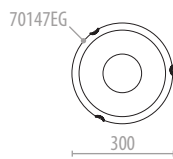

70147
Ø 300 - VE/PU: 1
1 x 60 W - E27 - 230V

A++ bis E



9 003348 142532

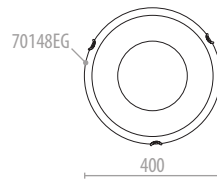

70148
Ø 400 - VE/PU: 1
2 x 60 W - E27 - 230V

A++ bis E



9 003348 142549

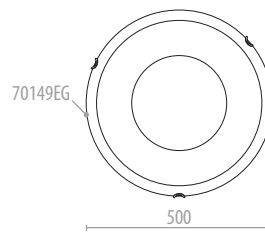

70149
Ø 500 - VE/PU: 1
3 x 60 W - E27 - 230V

A++ bis E



9 003348 142556



Metall • Glas
metal • glass
métal • verre

60W - E27 | 230V

Stahl gebürstet • Chrom • Glas
metal brushed • chrome • glass
métal brossé • chrome • verre

60W  E27 230V

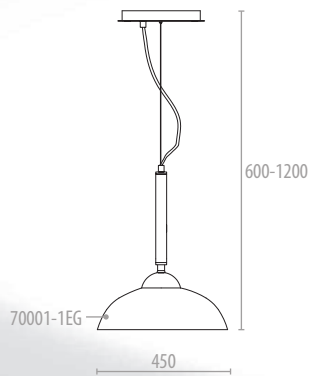

70001-1

Ø 450 x 135 • ↓ 1200 • VE/PU: 2
1 x 60 W • E27 • 230V

A++ bis E

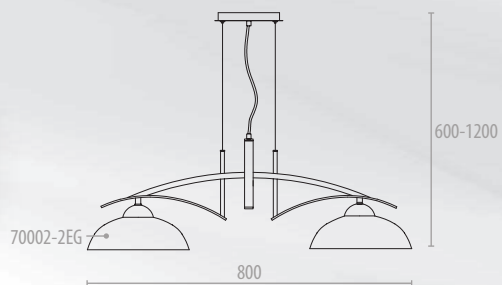

70002-2

800 x 300 • ↓ 1200 • VE/PU: 4
2 x 60 W • E27 • 230V

A++ bis E

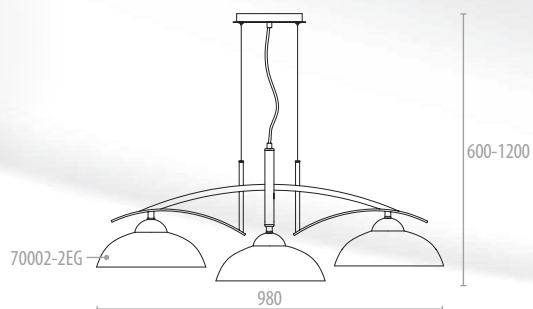

70002-3

980 x 300 • ↓ 1200 • VE/PU: 4
3 x 60 W • E27 • 230V

A++ bis E



70001-1



70001-3



70001-2

Messing antik • Glas
brass antique • glass
laiton antique • verre

60W  E27 230V

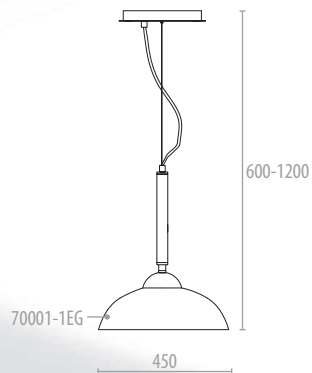

70002-1

Ø 450 x 135 • ↓ 1500 • VE/PU: 2
1 x 60 W • E27 • 230V

A++ bis E

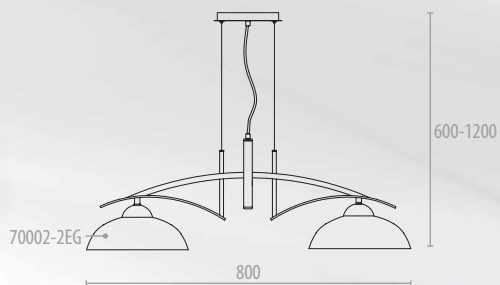

70002-2

800 x 300 • ↓ 1200 • VE/PU: 4
2 x 60 W • E27 • 230V

A++ bis E

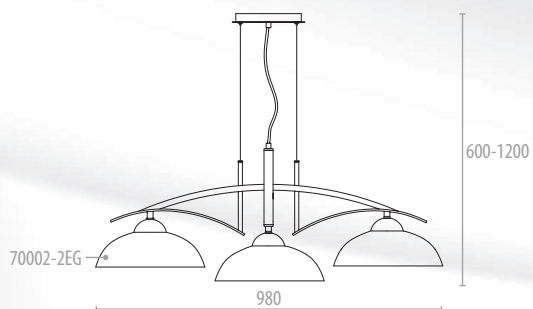

70002-3

980 x 300 • ↓ 1200 • VE/PU: 4
3 x 60 W • E27 • 230V

A++ bis E



70002-1



70002-3



70002-2

Stahl gebürstet • Glas
metal brushed • glass
métal brossé • verre

40W  E14 230V

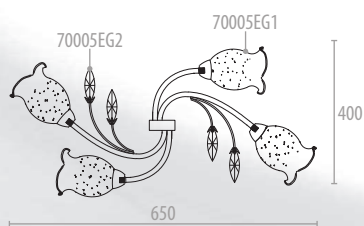

70005-4

650 x 400 x 180 • VE/PU: 4
4 x 40 W • E14 • 230V

A++ bis E



9 1003348 1122923

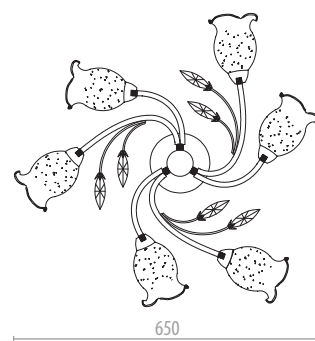

70005-6

Ø 650 • ↓ 220 • VE/PU: 4
6 x 40 W • E14 • 230V

A++ bis E



9 1003348 1124484





70005-6



70005-4



41600-4



41600-3

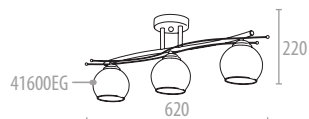

41600-3

↔ 620 • ↑ 220 • VE/PU: 6
3 x 40 W • E14 • 230V

A++ bis E



9 003348 114317

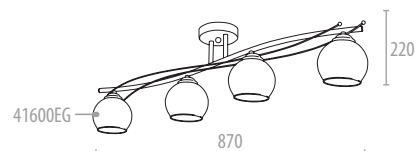

41600-4

↔ 870 • ↑ 220 • VE/PU: 4
4 x 40 W • E14 • 230V

A++ bis E



9 003348 1114324

Stahl gebürstet • Chrom • Glas
metal brushed • chrome • glass
métal brossé • chrome • verre

40W E14 230V

CINDY, VENETA



970101-6



41605-4



CINDY

Stahl gebürstet • Chrom • Glas
metal brushed • chrome • glass
métal brossé • chrome • verre

40W		E27	230V
type: A45, Ø45, ↔75mm			
Tropfen • drop • goutte			

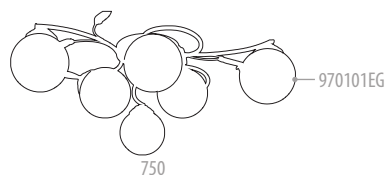

970101-6

↔ 750 • ↑ 200 • VE/PU: 4
6 x 40 W • E27 • 230V

A++ bis E



9 1003348 1890044

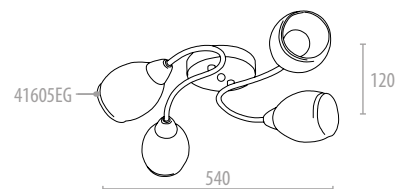

41605-4

540 x 440 • ↑ 120 • VE/PU: 6
4 x 40 W • E14 • 230V

A++ bis E



9 1003348 114348

VENETA



Stahl gebürstet • Glas
metal brushed • glass
métal brossé • verre

40W		E14	230V
-----	--	-----	------



997106-3



997106-1



997106-4

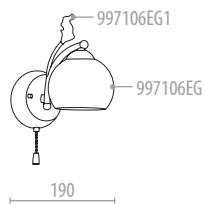

997106-1
Ø 140 • ↔ 190 • ↑ 210 • VE/PU: 10
1 x 60 W • E27 • 230V

A++ bis E



9 100334818796291

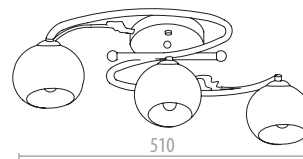

997106-3
510 x 350 • VE/PU: 4
3 x 60 W • E27 • 230V

A++ bis E



9 100334818796051

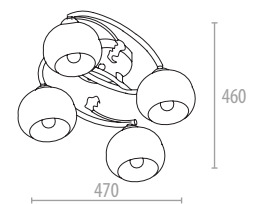

997106-4
470 x 460 • VE/PU: 4
4 x 60 W • E27 • 230V

A++ bis E



9 100334818796121

Stahl gebürstet • Opalglas
metal brushed • glass opal
métal brossé • verre opale

60W E27 230V



997118-5



997119-5

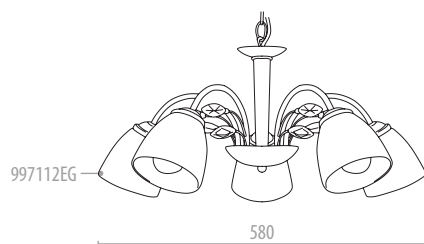

997118-5 ●
 Ø 580 - VE/PU: 4
 5 x 40 W - E14 - 230V
 Stahl gebürstet • Glas
 metal brushed • glass
 métal brossé • verre

A++ bis E



997119-5 ●
 Ø 580 - VE/PU: 4
 5 x 40 W - E14 - 230V
 Messing gebürstet • Glas
 brass brushed • glass
 laiton brossé • verre

A++ bis E



40W E14 230V



70007-4



70007-3

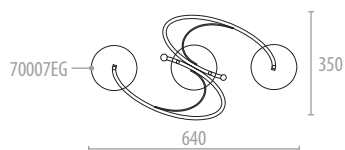

70007-3

↔ 640 x 350 x 190 - VE/PU: 4
3 x 40 W - E14 - 230V

A++ bis E



9 003348 124415

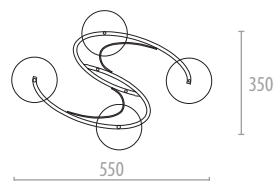

70007-4

↔ 550 x 350 x 190 - VE/PU: 4
4 x 40 W - E14 - 230V

A++ bis E



9 003348 122930

Stahl gebürstet • Glas
metal brushed • glass
métal brossé • verre

40W E14 230V



70010-5



70010-1

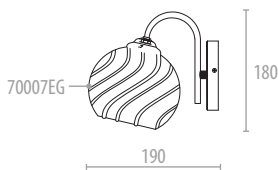

70010-1

↑ 180 • ↔ 125 • ← 190 • VE/PU: 4
1 x 40 W • E14 • 230V

A++ bis E

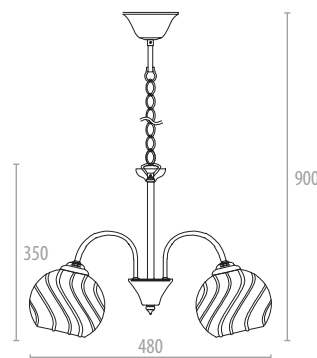

70010-5

Ø 480 • ↓ 900 • VE/PU: 4
5 x 40 W • E14 • 230V

A++ bis E



Stahl gebürstet • Glas
metal brushed • glass
métal brossé • verre

40W  E14 230V

Stahl gebürstet • Chrom • Glas
metal brushed • chrome • glass
métal brossé • chrome • verre

60W  E27 | 230V



63170-2

↔ 690 x 360 - VE/PU: 4
2 x 60 W - E27 - 230V

A++ bis E



63170-5

Ø 640 x 360 - VE/PU: 2
5 x 60 W - E27 - 230V

A++ bis E

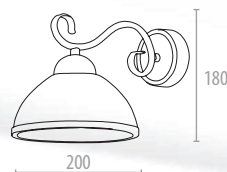

63171

Ø 200 • ↓ 180 - VE/PU: 6
1 x 60 W - E27 - 230V

A++ bis E



63170-2



63170-5



63171



63173-2

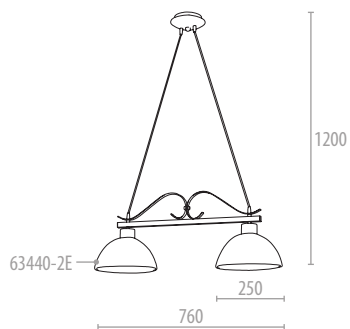

63173-2

↔ 760 • VE/PU: 4
2 x 60 W • E27 • 230V

60W  E27 230V

A++ bis E



Stahl gebürstet • Chrom • Glas
metal brushed • chrome • glass
métal brossé • chrome • verre



997040-2

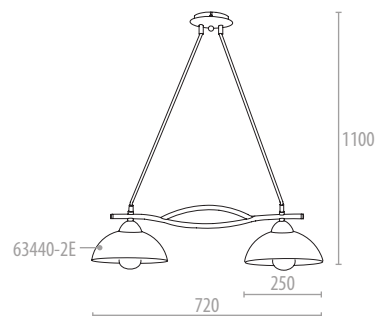

997040-2

↔ 720 • VE/PU: 4
2 x 60 W • E27 • 230V

A++ bis E



Stahl gebürstet • Glas
metal brushed • glass
métal brossé • verre

60W  E27 230V



03

Wand- & Deckenleuchten wall- & ceiling lights appliques et plafonniers

LOTUS	03	JASPIS	32	SPIRA	57
POLAR	04	CRYSTALLITE	33	CAROLINA	58
DION	05	KRISTIN	34	GINA	58
SPACY	06	LARISSA	35	CAROLINA	59
PRIMA	07	FEELING	36	MAGMA	61
PROTEUS	08	LAYER	37	PEARL	63
SOFT	9	XILO	38	SERENA	65
WEGA MC	10	ELINA	39	ELENA EVO	67
LUNEA	11	METROPOL	40	TORRO	69
STARLIGHT	12	ORNAMENT	41	TAURUS	70
PROTEUS	13	CRISTALLO	42	CHROMO	71
STARLIGHT	14	GEMINI	44	STEREO	72
PROTEUS	15	MOON	45	SPARK	73
DOMINO	17	ALBA	46	CURVE	74
RITA	19	FLOWER POWER	47	MARINA	75
AVEO	21	SUNNY	48	BARRETTE	76
NELIS	23	ZOO	48	LUMA	77
BALENO	25	CAMARA	49	ORION	78
ROMINA	27	OHARA	51	DIMMER	79
KIANA	28	JASON	53	BELT	80
KRISTALL	29	SATELLITE	54	PICTURE LIGHT	81
ELEGANCE	31	SINUS	55		



746052



Step1: 3000K



Step2: 4500K



Step3: 6000K

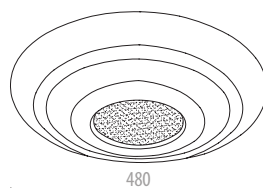

Metall • Acryl
metal • acrylic
métal • acrylique

incl. SMD LED

746052

Ø 480 x 85 • VE/PU: 2
incl. 1 x 36 W • SMD-LED • 2880lm • 3000K • A

A 2880lm • 36 kWh/1000h • 230V



9100334811434541



746055

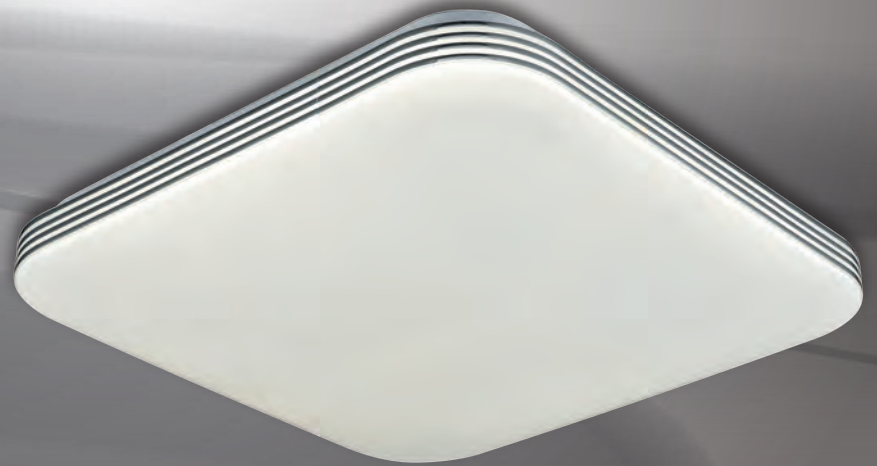
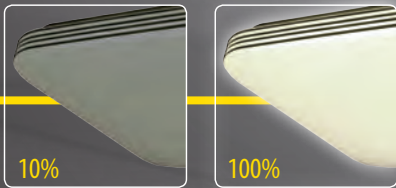
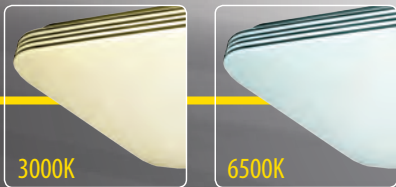

746054



540



340

746055

540 x 540 x 90 - VE/PU: 4
incl. 1 x 48 W - SMD-LED - 3600lm - 3000-6500K - A+

A+ 3600lm - 48 kWh/1000h - 230V



9 003348 143058



746054

340 x 340 x 90 - VE/PU: 4
incl. 1 x 24 W - SMD-LED - 1800lm - 4000K - A+

A+ 1800lm - 24 kWh/1000h - 230V



9 003348 143041



Metall • Acryl
metal • acrylic
métal • acrylique

incl. SMD LED



tauschbar
↔
changeable



747005

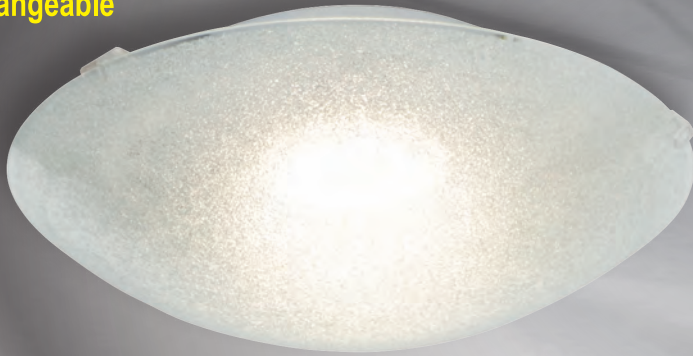

747004



747003



tauschbar
↔
changeable

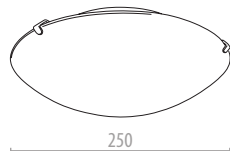

Metall • Glas
metal • glass
métal • verre

incl. 9W E27 LED 230V

747003

Ø 250 • VE/PU: 10
incl. 1 x 9W • E27 • 806lm • 3000K • A+
A+ 806lm • 9 kWh/1000h • 230V



9 003348 115998 1



747004

Ø 250 • VE/PU: 10
incl. 1 x 9W • E27 • 806lm • 3000K • A+
A+ 806lm • 9 kWh/1000h • 230V



9 003348 114353 9

747005

Ø 250 • VE/PU: 10
incl. 1 x 9W • E27 • 806lm • 3000K • A+
A+ 806lm • 9 kWh/1000h • 230V



9 003348 114459 8

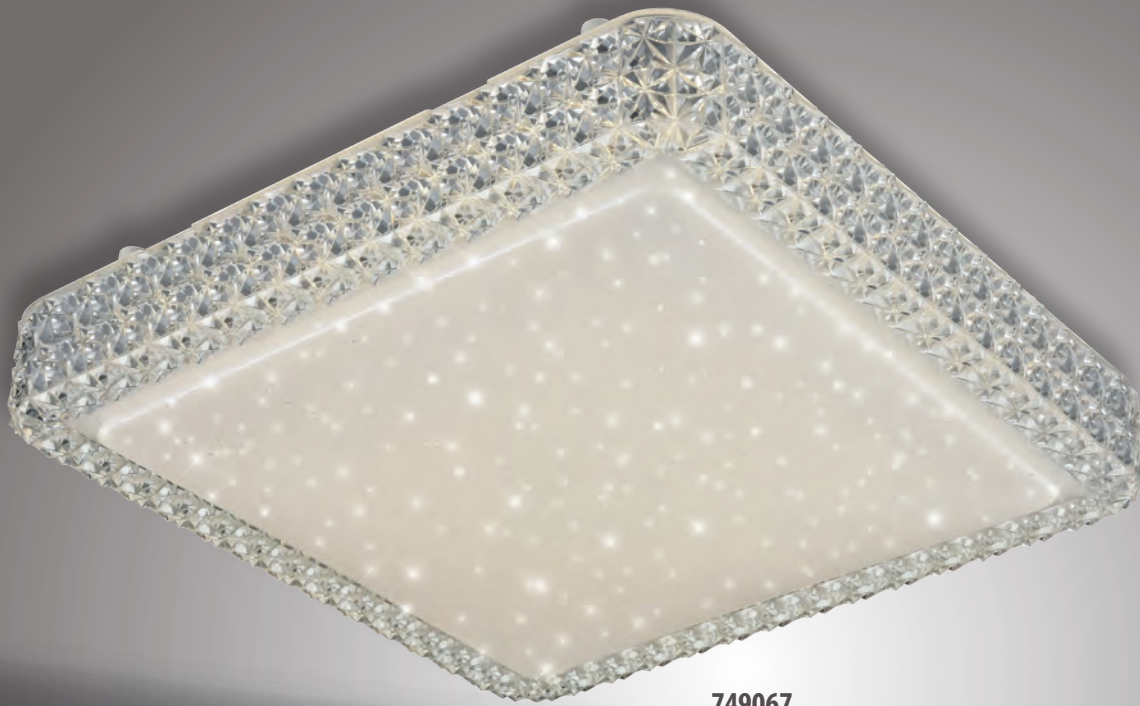

749067



749066

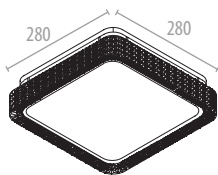

749066

280 x 280 x 90 • VE/PU: 10
incl. 1 x 12 W • SMD-LED • 960lm • 3000K • A+

A+ 960lm • 12 kWh/1000h • 230V



9 003348 11435151

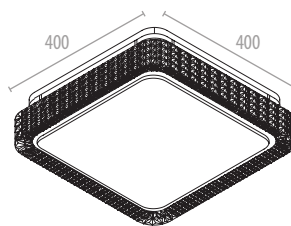

749067

400 x 400 x 90 • VE/PU: 6
incl. 1 x 24 W • SMD-LED • 1920lm • 3000K • A+

A+ 1920lm • 24 kWh/1000h • 230V



9 003348 11435222



Metall • Acryl
metal • acrylic
métal • acrylique

incl. SMD LED

BlueTooth



746031



746030

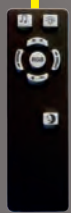
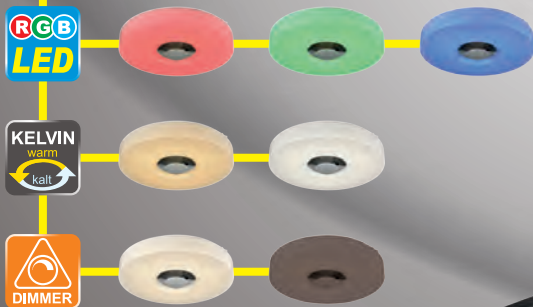
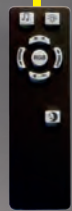
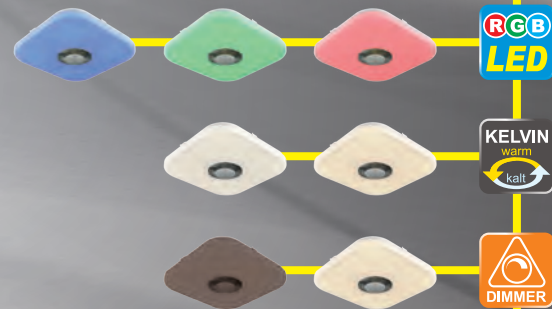

BlueTooth

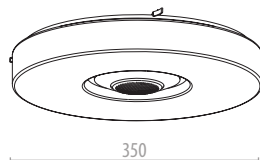

746030

Ø 350 x 90 - VE/PU: 4
incl. 1 x 15 W - SMD-LED - 1160lm - 2700-6000K - A+

A+ 1160lm - 15 kWh/1000h - 230V



9 10033481157253

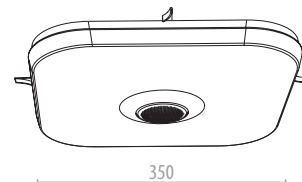

746031

350 x 350 x 75 - VE/PU: 3
incl. 1 x 15 W - SMD-LED - 1160lm - 2700-6000K - A+

A+ 1160lm - 15 kWh/1000h - 230V



9 10033481143461

Metall • Acryl
metal • acrylic
métal • acrylique

incl. SMD LED

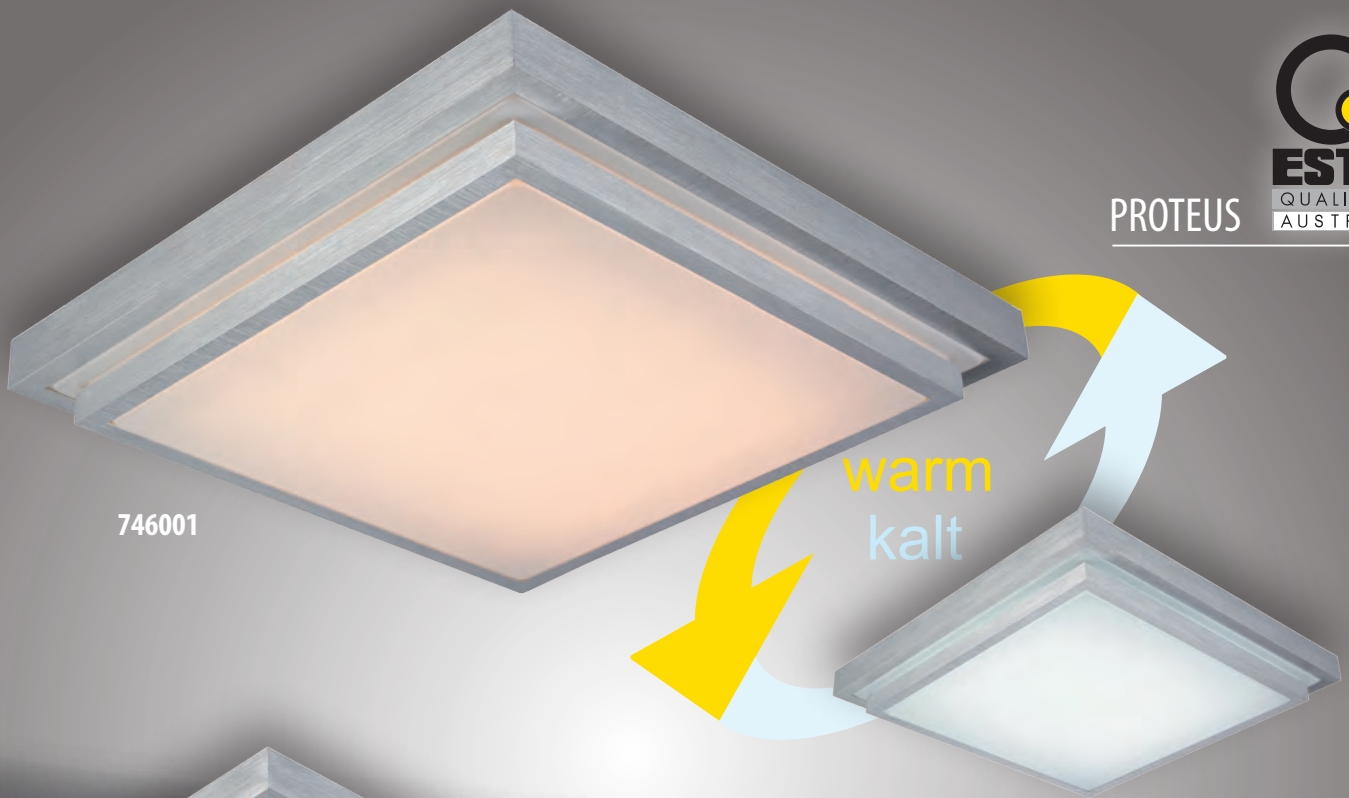

746001

warm
kalt

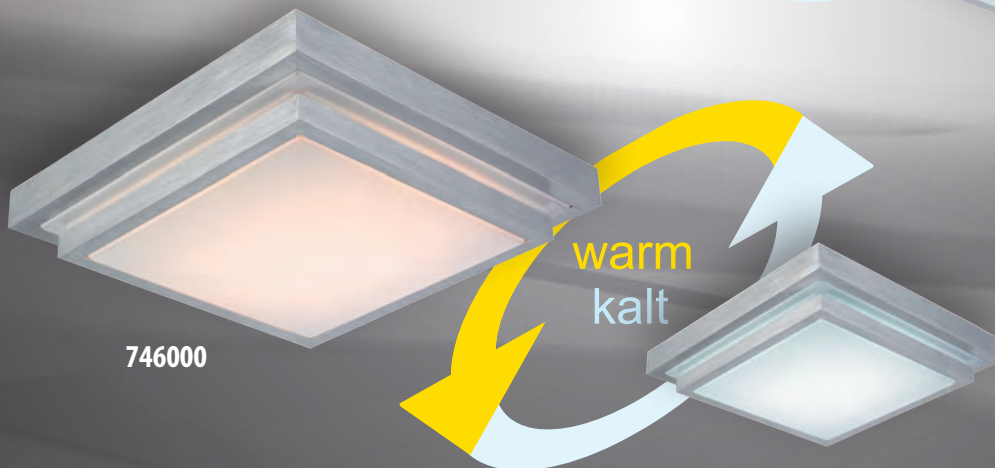

746000

warm
kalt



Stufenlos / stepless - COLOUR
3000 - 6500 Kelvin

Stufenlos / stepless - dimmer

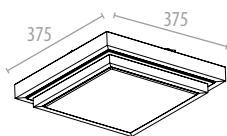

746000

375 x 375 x 100 - VE/PU: 4
incl. 1 x 30 W - SMD-LED - 2020lm - 3000/6500K - A+

A+ 2020lm - 30 kWh/1000h - 230V



9 1003348 119862

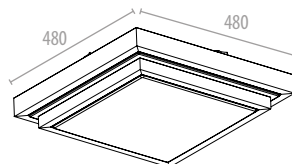

746001

480 x 480 x 100 - VE/PU: 2
incl. 1 x 50 W - SMD-LED - 3980lm - 3000/6500K - A+

A+ 3980lm - 50 kWh/1000h - 230V



9 1003348 119879



Aluminium gebürstet • Kunststoff
aluminium brushed • plastic
aluminium brossé • plastique

incl. SMD LED



741005



741004



746021

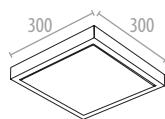
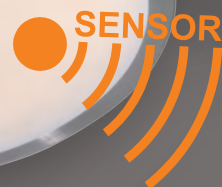

741004

300 x 300 x 90 • VE/PU: 8
incl. 1 x 16 W • SMD-LED
1400lm • 3000K • A+

A+ 1400lm
16 kWh/1000h • 230V

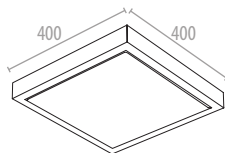

741005

400 x 400 x 90 • VE/PU: 8
incl. 1 x 24 W • SMD-LED
2100lm • 3000K • A+

A+ 2100lm
24 kWh/1000h • 230V

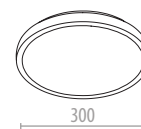

746021

Ø 300 x 90 • VE/PU: 10
incl. 1 x 16 W • SMD-LED
1400lm • 3000K • A+

A+ 1400lm
16 kWh/1000h • 230V



Stahl gebürstet • Acryl
metal brushed • acrylic
métal brossé • acrylique

incl. SMD LED



749204



749203

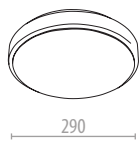

749203

Ø 290 x 90 • VE/PU: 4
incl. 1 x 16 W • SMD-LED Board • 1600lm • 3000K • A+

A+ 1600lm • 14 kWh/1000h • 230V



9 003348 110106 5

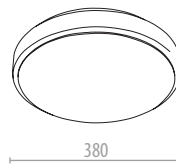

749204

Ø 380 x 105 • VE/PU: 3
incl. 1 x 18 W • SMD-LED Board • 1800lm • 3000K • A+

A+ 1800lm • 18 kWh/1000h • 230V



9 003348 110107 2



Chrom • Acryl
chrome • acrylic
chrome • acrylique

incl. SMD LED



746069



746068



746067

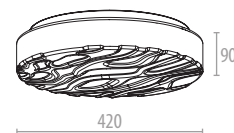
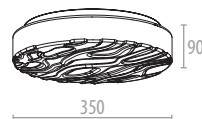
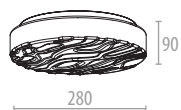

746067

Ø 280 · ↑ 90 · VE/PU: 6
incl. 1 x 15 W · SMD-LED · 960lm · 3000K · A

A → 960lm · 15 kWh/1000h · 230V



9 003348 143287

746068

Ø 350 · ↑ 90 · VE/PU: 3
incl. 1 x 18 W · SMD-LED · 1200lm · 3000K · A

A → 1200lm · 18 kWh/1000h · 230V



9 003348 143294

746069

Ø 420 · ↑ 90 · VE/PU: 3
incl. 1 x 24 W · SMD-LED · 1680lm · 3000K · A

A → 1680lm · 24 kWh/1000h · 230V



9 003348 143300

incl. SMD LED



746091



746090

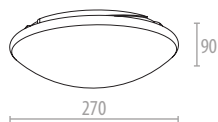

746091
Ø 270 x 90 • VE/PU: 4
incl. 1 x 11,5 W • SMD-LED • 800lm • 4000K • A+
A+ 800lm • 12 kWh/1000h • 230V



9 003348 143614

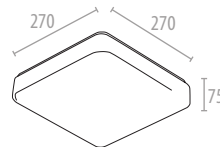

746090
270 x 270 x 75 • VE/PU: 4
incl. 1 x 11,5 W • SMD-LED • 800lm • 4000K • A+
A+ 800lm • 12 kWh/1000h • 230V



9 003348 141450



Metall • Acryl
metal • acrylic
métal • acrylique

incl. SMD LED



749246



749245



749248

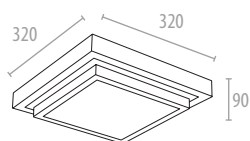

749245

320 x 320 x 90 • VE/PU: 6
incl. 1 x 16 W • SMD-LED • 1280lm • 3000K • A+

A+ 1280lm • 16 kWh/1000h • 230V



9 1003348 119060

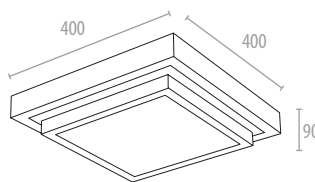

749246

400 x 400 x 90 • VE/PU: 6
incl. 1 x 24 W • SMD-LED • 1920lm • 3000K • A+

A+ 1920lm • 24 kWh/1000h • 230V



9 1003348 119077

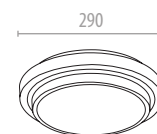

749248

Ø 290 x 90 • VE/PU: 8
incl. 1 x 16 W • SMD-LED • 1400lm • 3000K • A+

A+ 1400lm • 16 kWh/1000h • 230V



9 1003348 110777

Aluminium gebürstet • Acryl
aluminium brushed • acrylic
aluminium brossé • acrylique

incl. SMD LED



746043



746042



746046

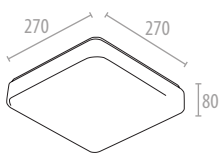

746042

270 x 270 x 80 - VE/PU: 4
incl. 1 x 12 W - SMD-LED - 1060lm - 4000K - A+

A+ 1060lm - 12 kWh/1000h - 230V



9 003 348 1 157 291

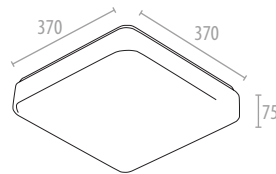

746043

370 x 370 x 75 - VE/PU: 4
incl. 1 x 24 W - SMD-LED - 2220lm - 4000K - A+

A+ 2220lm - 24 kWh/1000h - 230V



9 003 348 1 157 727

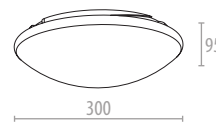

746046

Ø 300 x 95 - VE/PU: 4
incl. 1 x 15 W - SMD-LED - 1220lm - 4000K - A+

A+ 1220lm - 15 kWh/1000h - 230V



9 003 348 1 157 734



Metall • Acryl
metal • acrylic
métal • acrylique





749241



749240

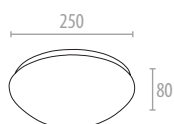

749240

Ø 250 x 80 - VE/PU: 6
incl. 1 x 12 W - SMD-LED • 1000lm • 3000K • A+

A+ 1000lm • 12 kWh/1000h • 230V



9 400334 811904 6

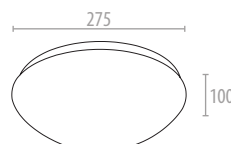

749241

Ø 275 x 100 - VE/PU: 6
incl. 1 x 16 W - SMD-LED • 1400lm • 3000K • A+

A+ 1400lm • 16 kWh/1000h • 230V



9 400334 811905 3

Metall • Acryl
metal • acrylic
métal • acrylique

incl. SMD LED



749242



740115

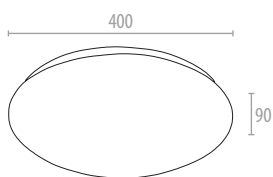

749242

Ø 410 • VE/PU: 5
incl. 1 x 24 W • SMD-LED • 1620lm • 3000K • A

A 1620lm • 24 kWh/1000h • 230V



9 003348 107838

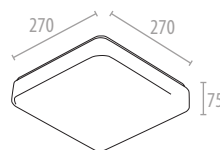

740115

270 x 270 x 75 • VE/PU: 4
incl. 1 x 15 W • SMD-LED • 900lm • 4000K • A

A 900lm • 15 kWh/1000h • 230V



9 003348 143270



Metall • Acryl
metal • acrylic
métal • acrylique

incl. SMD LED

Chrom • Aluminium • Acryl
chrome • Aluminium • acrylic
chrome • aluminium • acrylique

incl. SMD  LED

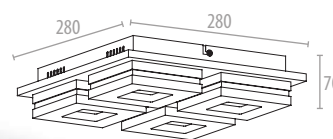

740044-4

280 x 70 x 280 - VE/PU: 6
incl. 4 x 5 W - SMD-LED - 350lm - 3000K - A+

A+ 1400lm - 20 kWh/1000h - 230V

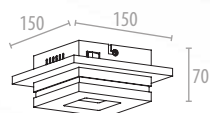

740044-1

150 x 70 x 150 - VE/PU: 20
incl. 1 x 5 W - SMD-LED - 350lm - 3000K - A+

A+ 350lm - 5 kWh/1000h - 230V

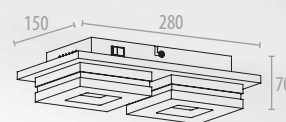

740044-2

280 x 70 x 150 - VE/PU: 10
incl. 2 x 5 W - SMD-LED - 350lm - 3000K - A+

A+ 700lm - 10 kWh/1000h - 230V



740044-1



740044-4



740044-2



740038-9



740038-1

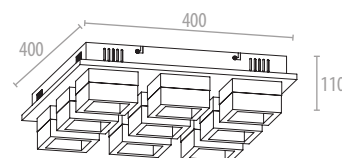
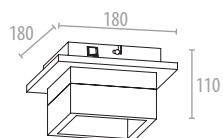

740038-1

180 x 180 x 110 - VE/PU: 12
incl. 1 x 8 W - SMD-LED - 560lm - 3000K - A+

A+ 560lm • 8 kWh/1000h - 230V



9 003348 118377



740038-9

400 x 400 x 110 - VE/PU: 4
incl. 9 x 4 W - SMD-LED - 277,78lm - 3000K - A+

A+ 2500lm • 36 kWh/1000h - 230V



9 003348 118384

Chrom • Acryl
chrome • acrylic
chrome • acrylique

incl. SMD LED

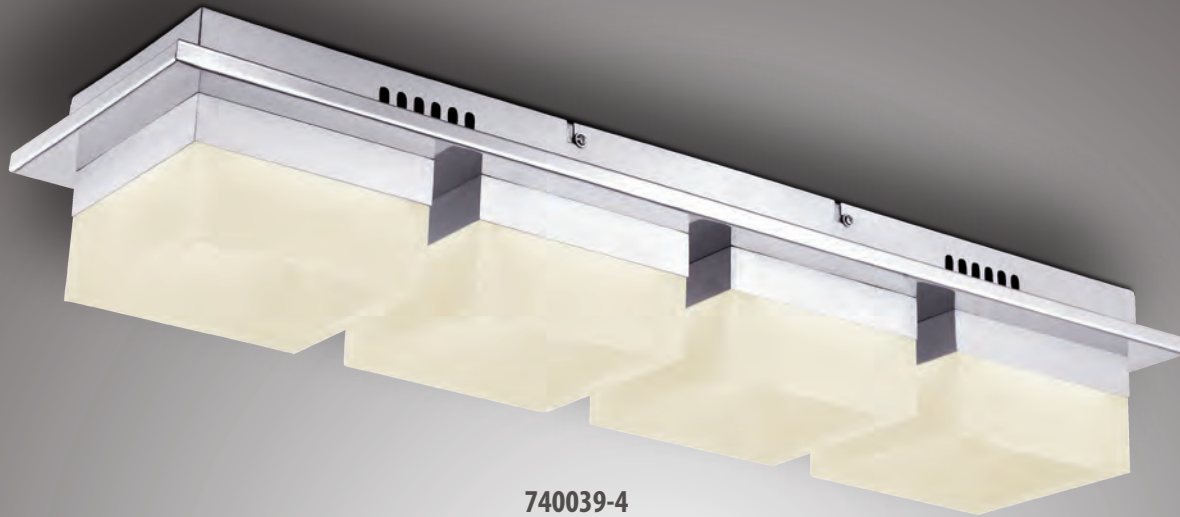

740039-4



740038-4

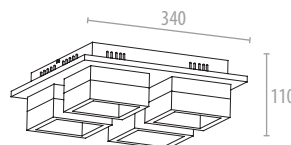
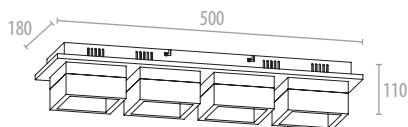

740039-4

500 x 180 x 110 - VE/PU: 6
incl. 4 x 8 W - SMD-LED - 562,5lm - 3000K - A+

A+ 2250lm - 32 kWh/1000h - 230V



9 003348 111836 0

740038-4

340 x 340 x 110 - VE/PU: 4
incl. 4 x 8 W - SMD-LED - 562,5lm - 3000K - A+

A+ 2250lm - 32 kWh/1000h - 230V



9 003348 111216 0

Chrom • Acryl
chrome • acrylic
chrome • acrylique

incl. SMD LED

Aluminium gebürstet • Chrom • Acryl
aluminium brushed • chrome • acrylic
aluminium brossé • chrome • acrylique

incl. SMD LED

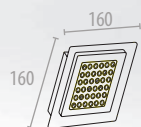

740072-1

160 x 160 x 70 - VE/PU: 1
incl. 1 x 7,2 W - SMD-LED
900lm - 3000K - A++

A++ 900lm

8 kWh/1000h - 230V

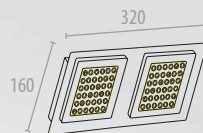

740072-2

320 x 160 x 70 - VE/PU: 1
incl. 2 x 7,2 W - SMD-LED
900lm - 3000K - A++

A++ 1800lm

15 kWh/1000h - 230V

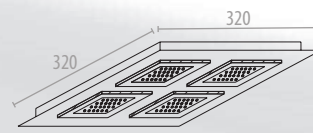

740072-4

320 x 320 x 70 - VE/PU: 1
incl. 4 x 7,2 W - SMD-LED
900lm - 3000K - A++

A++ 3600lm

29 kWh/1000h - 230V



740072-1



740072-4

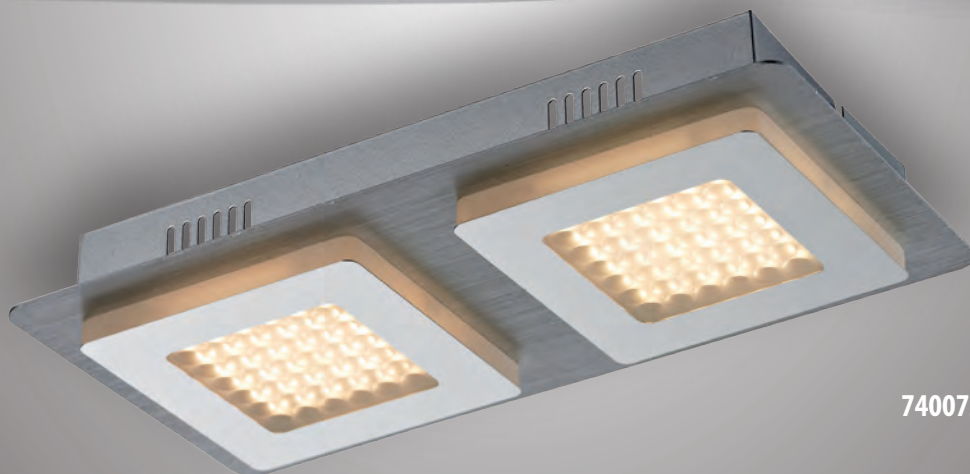

740072-2

Chrom • Glas
chrome • glass
chrome • verre

incl. SMD LED

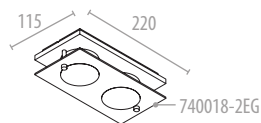

740018-2

220 x 115 x 65 - VE/PU: 16
incl. 2 x 5 W - SMD-LED - 400lm - 3000K - A+

A+ 800lm - 10 kWh/1000h - 230V



740018-1

115 x 115 x 65 - VE/PU: 16
incl. 1 x 5 W - SMD-LED - 400lm - 3000K - A+

A+ 400lm - 5 kWh/1000h - 230V

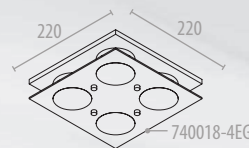

740018-4

220 x 220 x 65 - VE/PU: 8
incl. 4 x 5 W - SMD-LED - 400lm - 3000K - A+

A+ 1600lm - 20 kWh/1000h - 230V



740018-1



740018-4



740018-2

Stahl gebürstet • Glas
metal brushed • glass
métal brossé • verre

incl. Board GU10 5W LED

LED tauschbar
changeable 3.000K
warm white



89580

TAUSCHBARES
LED - Board
changeable
LED

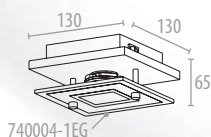

740004-1EG

740004-1

130 x 130 x 65 • VE/PU: 20
incl. 1 x 5 W • GU10 • 350lm • 3000K • A+
A+ 350lm • 5 kWh/1000h • 230V

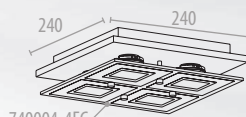

740004-4EG

740004-4

240 x 240 x 65 • VE/PU: 5
incl. 4 x 5 W • GU10 • 350lm • 3000K • A+
A+ 1400lm • 20 kWh/1000h • 230V

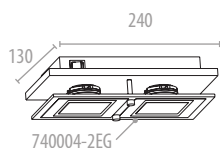

740004-2EG

740004-2

240 x 130 x 65 • VE/PU: 10
incl. 2 x 5 W • GU10 • 350lm • 3000K • A+
A+ 700lm • 10 kWh/1000h • 230V

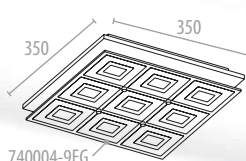

740004-9EG

740004-9

350 x 350 x 65 • VE/PU: 4
incl. 9 x 5 W • GU10 • 350lm • 3000K • A+
A+ 3150lm • 45 kWh/1000h • 230V

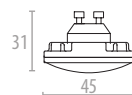

89580

Ø 45 x 31 • VE/PU: 10
5 W • GU10 • 350lm • 3000K • A+
A+ 350lm • 5 kWh/1000h • 230V



740004-1

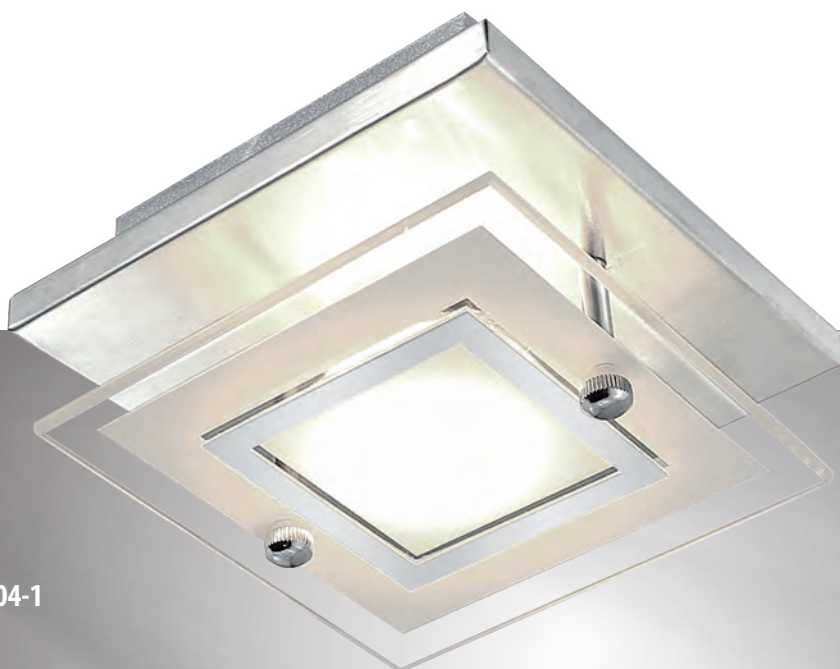



740004-9



740004-4



740004-2



LED 4000K
weiß • white • blanc

RGB LED

748011-5

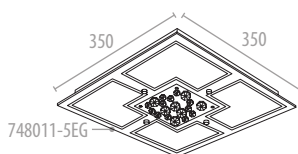
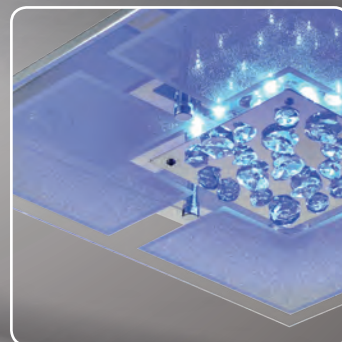
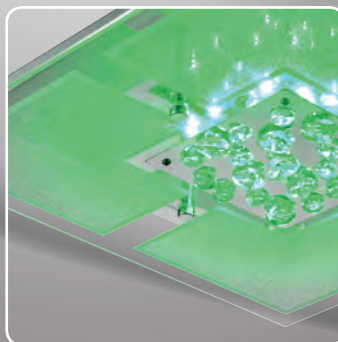

Chrom • Glas
chrome • glass
chrome • verre

748011-5

350 x 350 x 80 • VE/PU: 4
incl. 5 x 5,3 W • SMD-LED • 506lm • 4000K • A+
incl. RGB-LED

A+ 1530lm • 17 kWh/1000h • 230V



9 003348 158137



749029-5

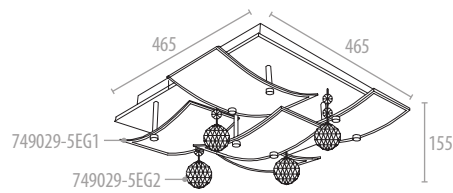

749029-5

465 x 465 x 155 • VE/PU: 4
incl. 5 x 5 W • SMD-LED • 300lm • 4000K • A+

A+ 1500lm • 25 kWh/1000h • 230V



Chrom • Glas
chrome • glass
chrome • verre

incl. SMD LED



998070-8



998090-5

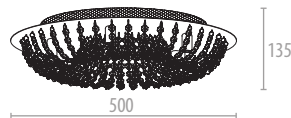

998090-5
Ø 500 - VE/PU: 5
5 x 42 W - G9 - 230V

A++ bis E



9 10033481892659

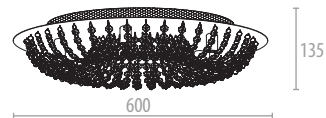

998070-8
Ø 600 x 135 - VE/PU: 3
8 x 42 W - G9 - 230V

A++ bis E



9 10033481876154

Chrom • Glas
chrome • glass
chrome • verre

42W G9 230V

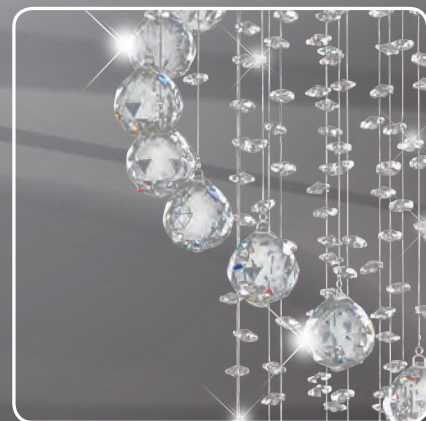

749091-5

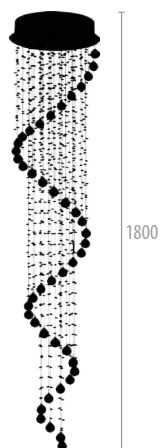

749091-5

Ø 400 • ↓ 1800 • VE/PU: 2

incl. 5 x 3 W • GU10 • 240lm • 4000K • A+

A+ 1200lm • 15 kWh/1000h • 230V



9 100334 8112919 91



749191-6

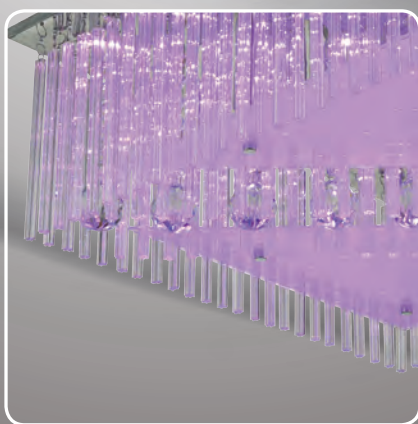

Chrom • Glas
chrome • glass
chrome • verre

42W  G9 230V

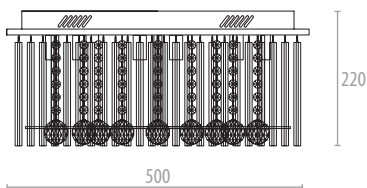

9749191-6

500 x 500 x 220 - VE/PU: 2

8 x 42 W • G9 • 230V

incl. LED rosa • pink • rose

A++ bis E





9749196-8

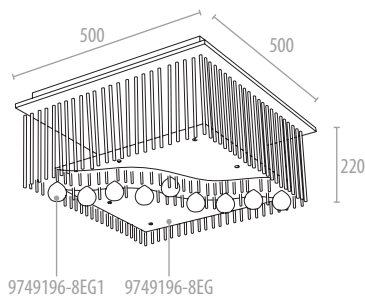
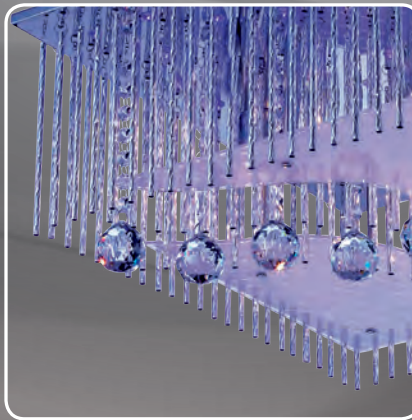

9749196-8

500 x 500 x 220 • VE/PU: 2

6 x 42 W • G9 • 230V

incl LED blau • blue • bleu

A++ bis E



Chrom • Glas • Aluminium
chrome • glass • aluminium
chrome • verre • aluminium

42W  G9 230V



940032-5

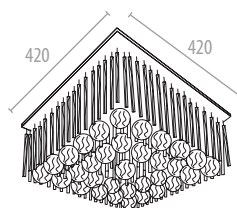

Chrom • Glas • Aluminium
chrome • glass • aluminium
chrome • verre • aluminium

42W  G9 230V

940032-5

420 x 420 • VE/PU: 2
5 x 42 W • G9 • 620lm • 2700K • C

A++ bis E





749001-6

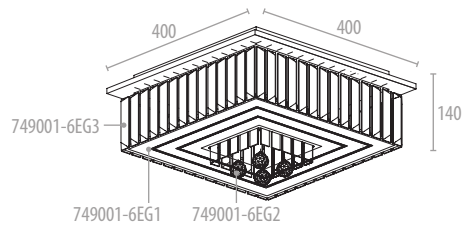

749001-6

400 x 400 x 140 - VE/PU: 4
incl. 6 x 3 W - SMD-LED - 195lm - 3000K - A+

A+ 1170lm - 18 kWh/1000h - 230V



Chrom • Glas
chrome • glass
chrome • verre

incl. SMD LED



749062-4



89581

TAUSCHBARES
LED - Board
changeable
LED

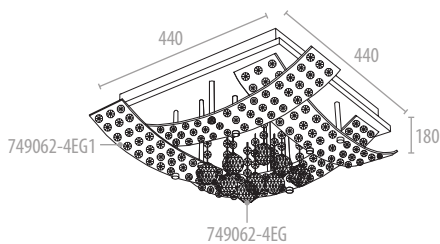

Chrom • Glas
chrome • glass
chrome • verre

749062-4

440 x 440 x 180 • VE/PU: 4
incl. 4 x 5 W • GU10 • 350lm • 4000K • A+

A+ 1400lm • 20 kWh/1000h • 230V

incl. Board GU10 5W LED



9 003348 124002



9740019

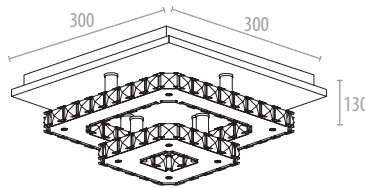

9740019

300 x 300 x 130 - VE/PU: 4
incl. 1 x 18 W - SMD-LED • 1530lm • 3000K • A+

A+ 1530lm • 18 kWh/1000h • 230V



Chrom • Acryl
chrome • acrylic
chrome • acrylique

incl. SMD  LED



748061



748063



748060

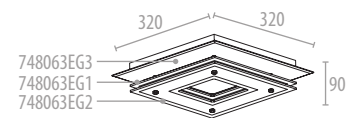
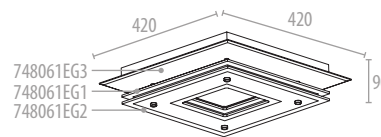
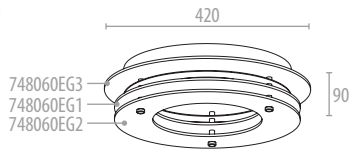

748060

Chrom • Glas
chrome • glass
chrome • verre

Ø 420 x 90 • VE/PU: 4
incl. 1 x 18 W • SMD-LED • 1620lm • 3000K • A+

A+ 1620lm • 18 kWh/1000h • 230V

incl. SMD LED



9 003348 156973

748061

420 x 420 x 90 • VE/PU: 4
incl. 1 x 18 W • SMD-LED • 1620lm • 3000K • A+

A+ 1620lm • 18 kWh/1000h • 230V



9 003348 156980

748063

320 x 320 x 90 • VE/PU: 4
incl. 1 x 12 W • SMD-LED • 1080lm • 3000K • A+

A+ 1080lm • 12 kWh/1000h • 230V



9 003348 1158151



740106-9

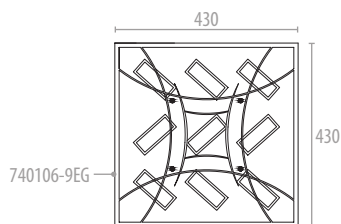
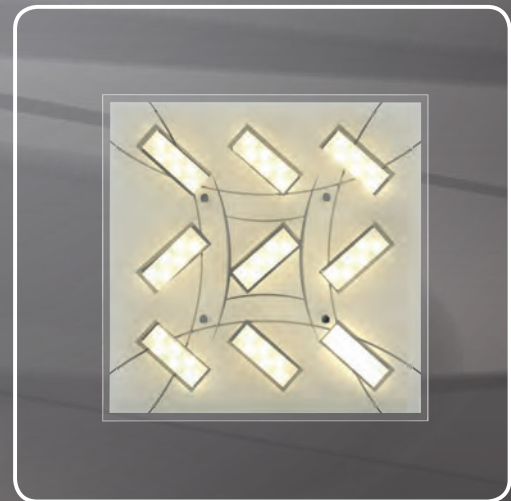

740106-9

430 x 90 x 430 - VE/PU: 4
incl. 9 x 3 W - SMD-LED - 300lm - 3000K - A+

A+ 2700lm - 27 kWh/1000h - 230V



Chrom • Glas
chrome • glass
chrome • verre

incl. SMD LED

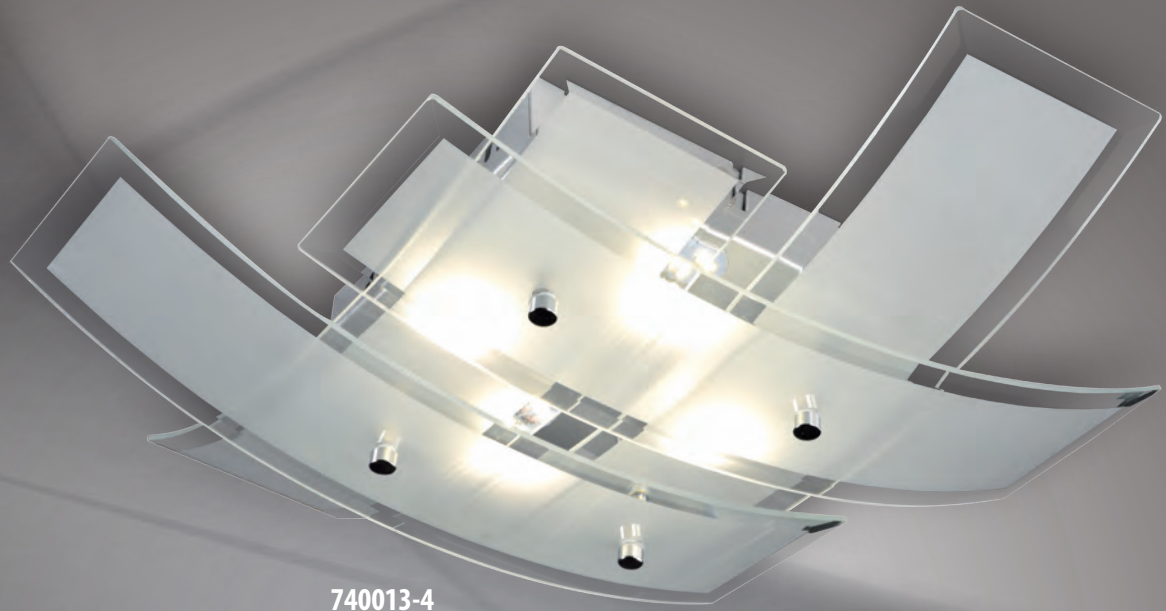

740013-4



740013-1



740013-2

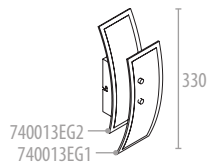

740013-1
330 x 130 x 70 • VE/PU: 20
incl. 1 x 5 W • SMD-LED
420lm • 4000K • A+

A+ 420lm
5 kWh/1000h • 230V



9 10033481110449

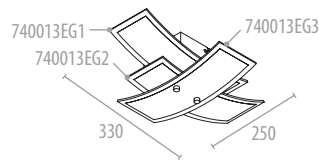

740013-2
330 x 250 x 80 • VE/PU: 20
incl. 2 x 3 W • SMD-LED
260lm • 4000K • A+

A+ 520lm
6 kWh/1000h • 230V



9 10033481110432

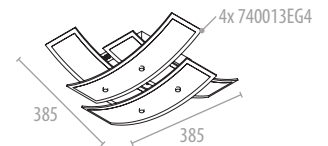

740013-4
385 x 385 x 80 • VE/PU: 8
incl. 4 x 3 W • SMD-LED
260lm • 4000K • A+

A+ 1040lm
12 kWh/1000h • 230V



9 10033481110456



Metall • Glas
metal • glass
métal • verre

incl. SMD LED



41586

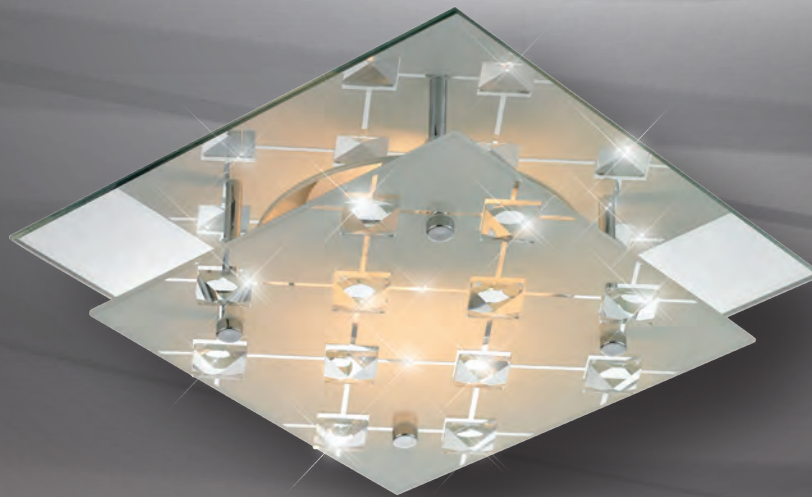

41585

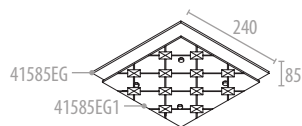

41585

240 x 240 x 85 • VE/PU: 10
1 x 60 W • E27 • 230V

A++ bis E

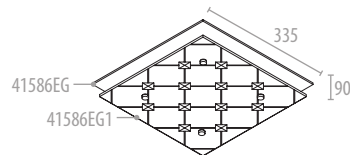

41586

335 x 335 x 90 • VE/PU: 5
2 x 60 W • E27 • 230V

A++ bis E



Metall • Glas
metal • glass
métal • verre

60W E27 230V



40038

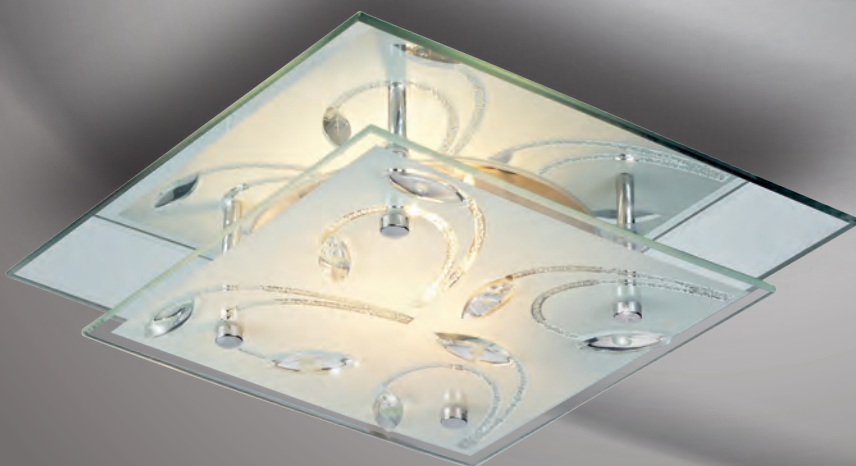

40037

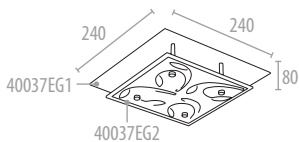

40037
240 x 240 x 80 - VE/PU: 5
1 x 60 W - E27 - 230V

A++ bis E



9 003348 118896

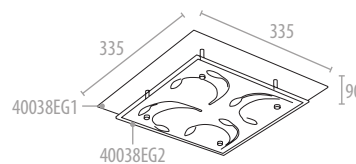

40038
335 x 335 x 90 - VE/PU: 4
2 x 60 W - E27 - 230V

A++ bis E



9 003348 118902

Chrom • Glas
chrome • glass
chrome • verre

60W E27 230V



994706

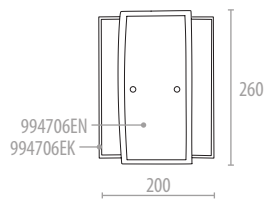

994706
200 x 260 - VE/PU: 5
1 x 70 W - R7s

A++ bis E



Chrom • Glas
chrome • glass
chrome • verre

70W 78mm R7s 230V



994809



994709

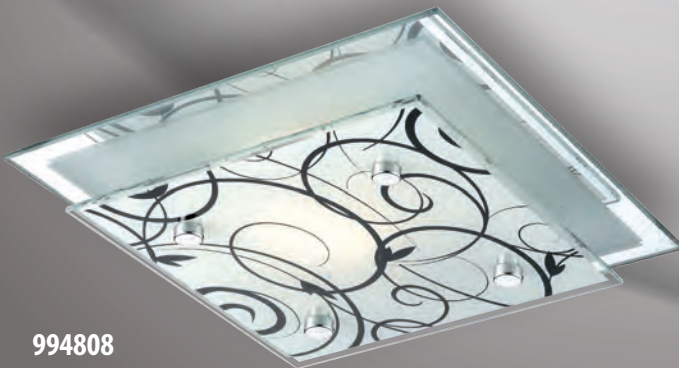

994808



994708



CRISTALLO FLORAL

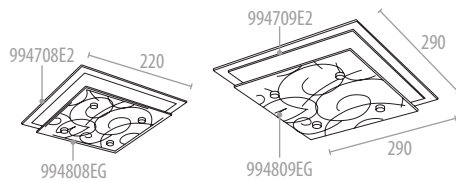

994808
220 x 220 - VE/PU: 10
1 x 60 W - E27 - 230V

A++ bis E

994809
290 x 290 - VE/PU: 10
2 x 60 W - E27 - 230V

A++ bis E

60W E27 230V



CRISTALLO

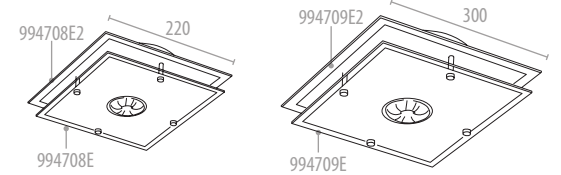

994708
220 x 220 - VE/PU: 10
1 x 60 W - E27 - 230V

A++ bis E

994709
300 x 300 - VE/PU: 10
2 x 60 W - E27 - 230V

A++ bis E

60W E27 230V
typ: A45 • Ø45 • ↔ 75mm
Tropfen • drop • goutte





947045



947044

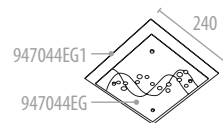

947044
240 x 240 x 75 • VE/PU: 10
1 x 60 W • E27 • 230V

A++ bis E

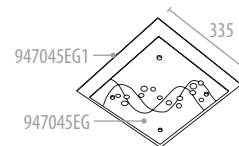

947045
335 x 335 x 80 • VE/PU: 5
2 x 60 W • E27 • 230V

A++ bis E



Chrom • Glas • Spiegelglas
chrome • glass • plate glass
chrome • verre • glace

60W E27 230V



41562



41561

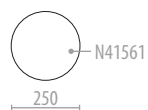

41561
Ø 250 • ↓ 105 • VE/PU: 3
1 x 60 W • E27 • 230V

A++ bis E

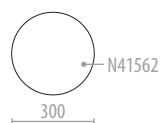

41562
Ø 300 • ↓ 95 • VE/PU: 4
2 x 60 W • E27 • 230V

A++ bis E



Metall • Opalglas
metal • glass opal
métal • verre opale

60W E27 230V



994075



994076



994077

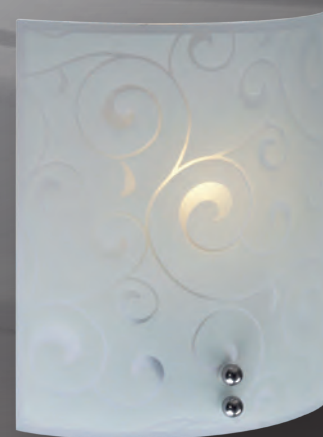

994078

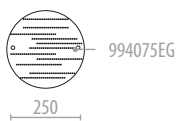

994075EG

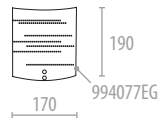

994077EG



994076EG

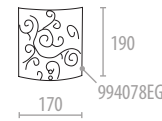

994078EG

994075
Ø 250 - VE/PU: 12
1 x 60 W - E27 - 230V

A++ bis E



9 1003348 1879278

994077
190 x 170 - VE/PU: 12
1 x 60 W - E27 - 230V

A++ bis E



9 1003348 1879285

994076
Ø 250 - VE/PU: 12
1 x 60 W - E27 - 230V

A++ bis E



9 1003348 1879292

994078
190 x 170 - VE/PU: 12
1 x 60 W - E27 - 230V

A++ bis E



9 1003348 1879308



Glas • Metall
glass • metal
verre • métal

60W  E27 230V



994771



994770

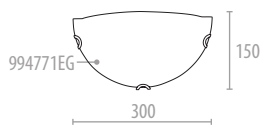

994770
↔ 300 • VE/PU: 10
1 x 60 W • E27 • 230V

A++ bis E



9 003348 894448

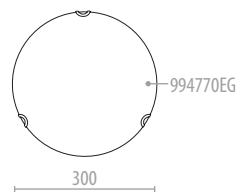

994771
Ø 300 • VE/PU: 10
1 x 60 W • E27 • 230V

A++ bis E



9 003348 894455

Chrom • Glas
chrome • glass
chrome • verre

60W E27 230V



48114

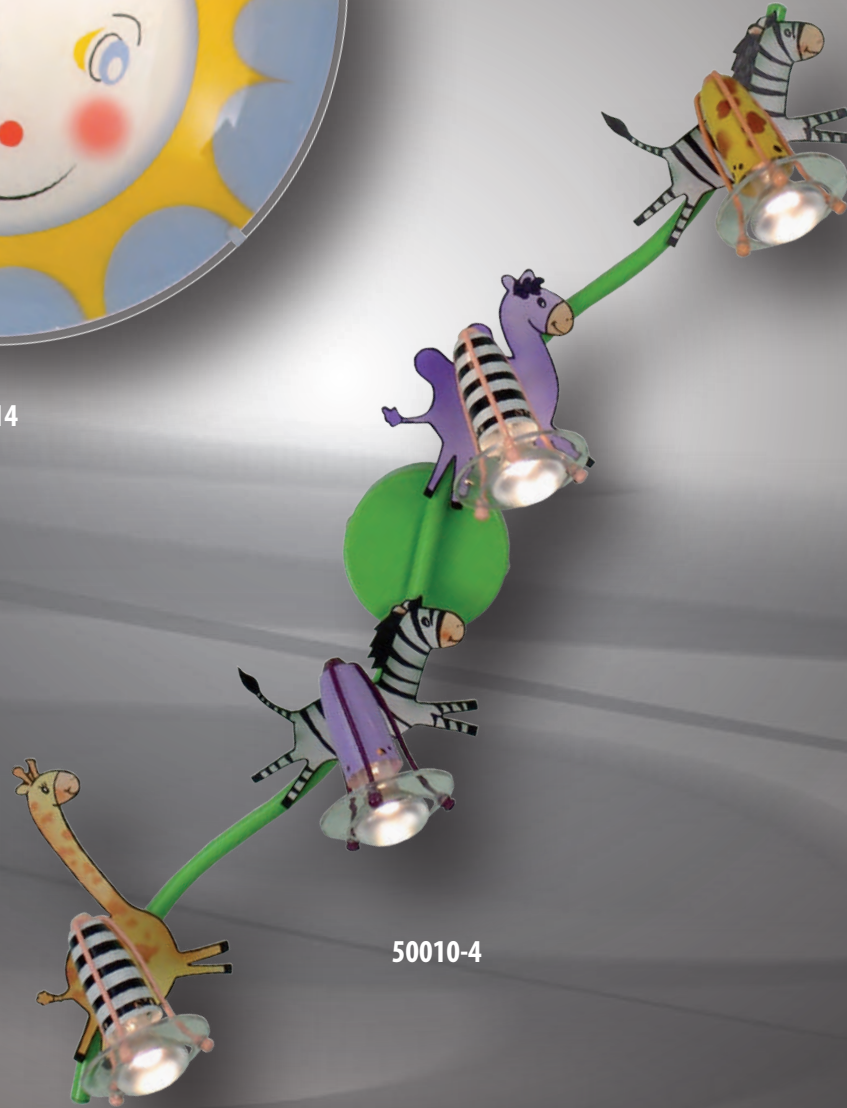

50010-4

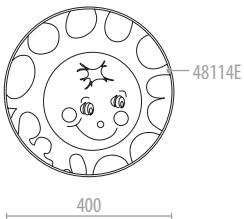

SUNNY



48114
Ø 400 • VE/PU: 6
2 x 60 W • E27 • 230V

A++ bis E

Glas • Metall
glass • metal
verre • métal

60W E27 | 230V



9 1003348 83739 1

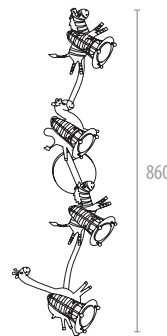

ZOO



50010-4
↑ 860 • VE/PU: 6
4 x 40 W • E14 • 230V

A++ bis E

Metall • Kunststoff
metal • plastic
métal • plastique

40W E14/R50 | 230V



9 1003348 84388 0



742038-6



742038-4



742038-4
710 x 250 • ↓ 120 • VE/PU: 4
incl. 4 x 4 W • SMD-LED • 320lm • 3000K • A+
A+ 1280lm • 16 kWh/1000h • 230V



9 003348 141665 1

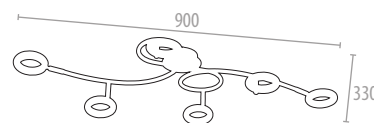

742038-6
900 x 330 • ↓ 220 • VE/PU: 4
incl. 6 x 4 W • SMD-LED • 320lm • 3000K • A+
A+ 1920lm • 24 kWh/1000h • 230V



9 003348 141672 2

Chrom • Acryl
chrome • acrylic
chrome • acrylique

incl. SMD LED



742038-9



742068-6

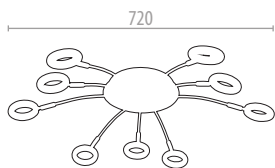

742038-9
Ø 720 • ↓ 220 • VE/PU: 2
incl. 9 x 4 W • SMD-LED • 320lm • 3000K • A+
A+ 2880lm • 36 kWh/1000h • 230V



9 003348 114168 9

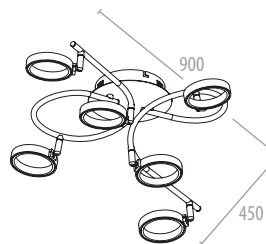

742068-6
900 x 450 • ↓ 280 • VE/PU: 2
incl. 6 x 4,8 W • SMD-LED • 330lm • 3000K • A+
A+ 1980lm • 29 kWh/1000h • 230V



9 003348 115713 0



Chrom • Acryl
chrome • acrylic
chrome • acrylique

incl. SMD LED



tauschbar
↔
changeable



780012-8



tauschbar
↔
changeable

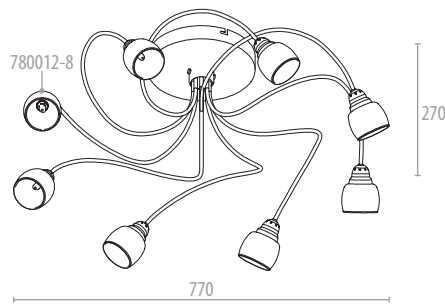

Chrom • Glas
chrome • glass
chrome • verre

incl. 3,5W G9 LED 230V

780012-8

Ø 770 • ↓ 270 • VE/PU: 2
incl. 8 x 3,5 W • G9 • 320lm • 3000K • A++

A++ 2560lm • 28 kWh/1000h • 230V





80012-8

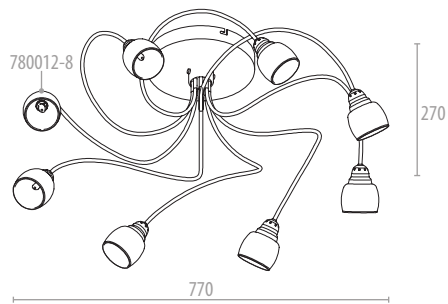
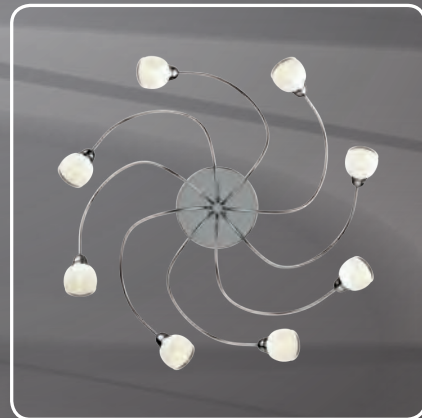

80012-8
Ø 770 • ↑ 270 • VE/PU: 2
8 x 33 W • G9 • 230V

A++ bis E



Chrom • Glas
chrome • glass
chrome • verre

33W  G9 230V

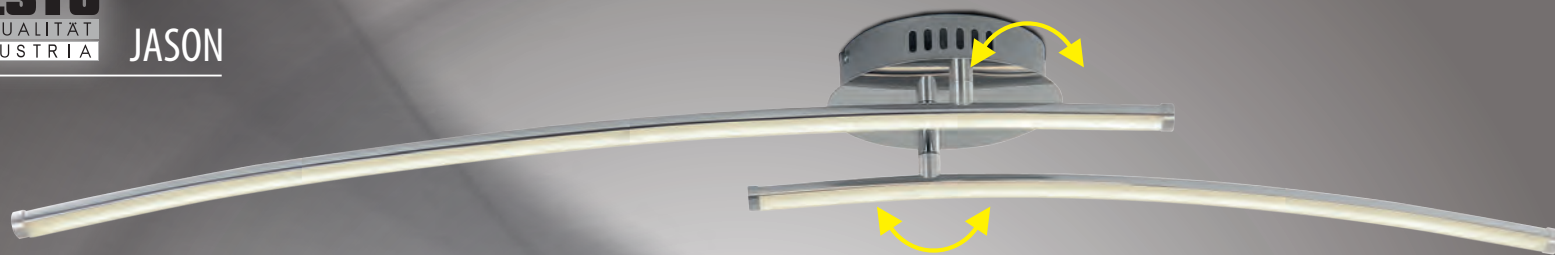

742046-2

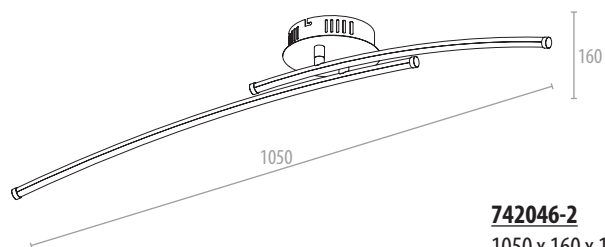

Chrom • Acryl
chrome • acrylic
chrome • acrylique

incl. SMD LED

742046-2

1050 x 160 x 135 • VE/PU: 8
incl. 2 x 7,5 W • SMD LED • 600lm • 3000K • A+

A+ 1200lm • 15 kWh/1000h • 230V



9100334811421671



42006-14



42006-12

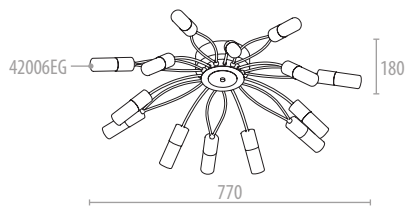
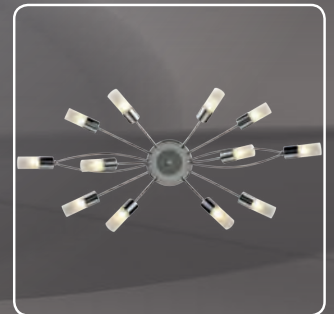

42006-14

770 x 750 x 180 - VE/PU: 1
14 x 9 W - G9-LED - 230V

A++ bis E



9 003348 143195

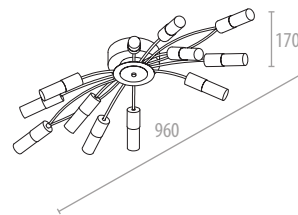

42006-12

960 x 400 x 170 - VE/PU: 1
12 x 9 W - G9-LED - 230V

A++ bis E



9 003348 143188



Stahl gebürstet • Chrom • Alu • Glas
metal brushed • chrome • Alu • glass
métal brossé • chrome • Alu • verre

33W  G9 230V



742015



742014

i „SINUS“
Tischleuchte • table
lamp • lampe de table

6.35

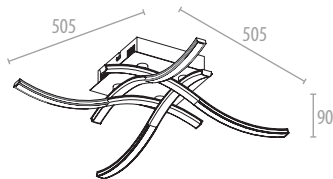

742014
505 x 505 x 90 • VE/PU: 6
incl. 1 x 16,8 W • SMD-LED • 1680lm • 3000K • A+
A+ 1680lm • 17 kWh/1000h • 230V



9 10033481154498

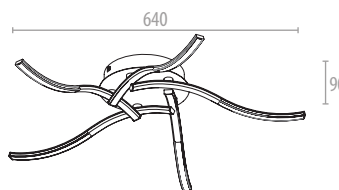

742015
Ø 640 x 90 • VE/PU: 6
incl. 1 x 20 W • SMD-LED • 1300lm • 3000K • A+
A+ 1300lm • 20 kWh/1000h • 230V



9 10033481154504

Stahl gebürstet • Kunststoff
metal brushed • plastic
métal brossé • plastique

incl. SMD LED

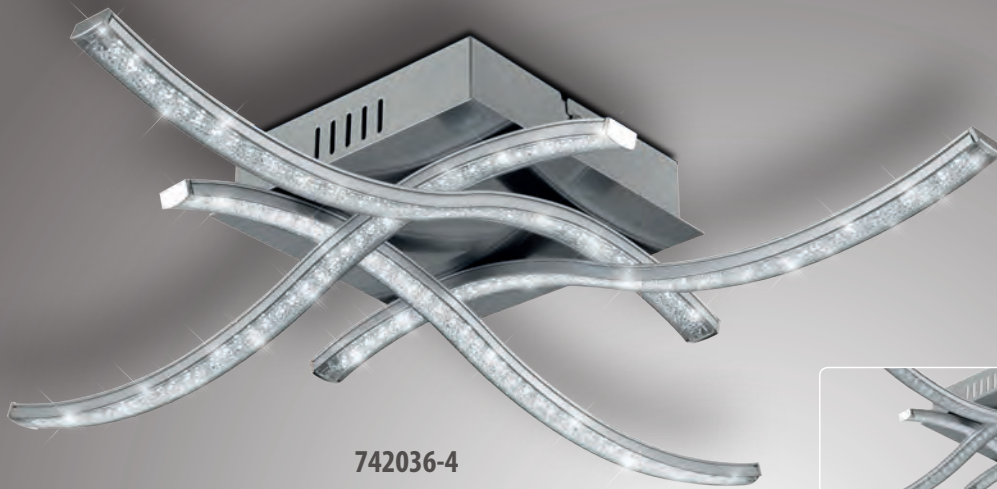

742036-4

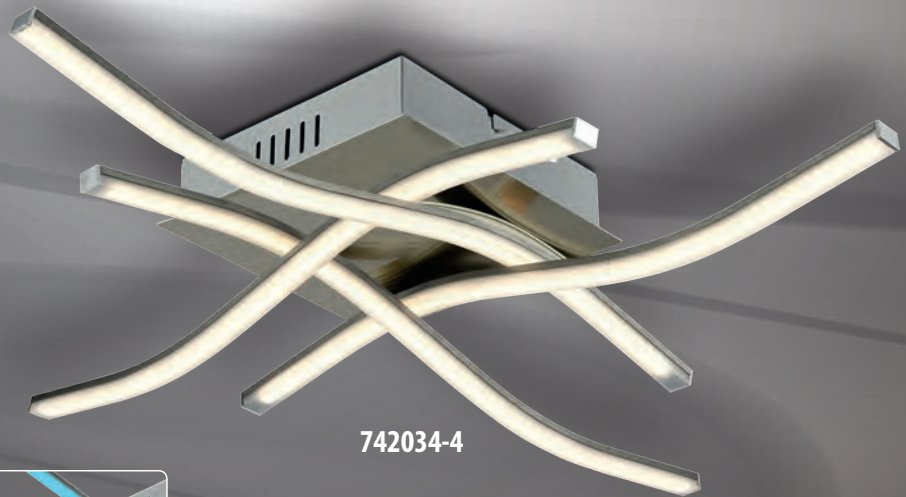
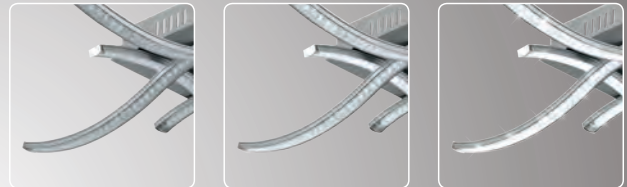

742034-4

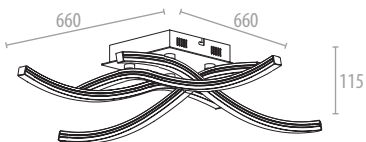
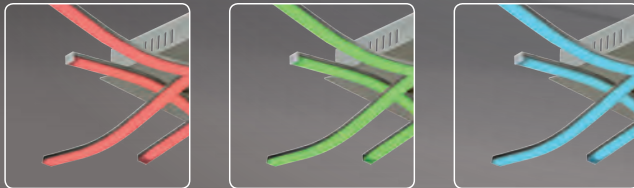

742034-4

660 x 660 x 115 - VE/PU: 4
incl. 4 x 6 W - SMD-LED - 420lm - 3000K - A+

A+ 1680lm - 24 kWh/1000h - 230V

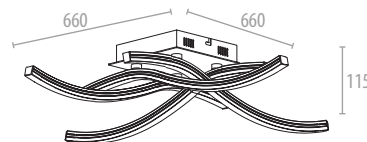

742036-4

660 x 660 x 115 - VE/PU: 4
incl. 4 x 6 W - SMD-LED - 420lm - 4000K - A+

A+ 1680lm - 24 kWh/1000h - 230V



Stahl gebürstet • Kunststoff
metal brushed • plastic
métal brossé • plastique

incl. SMD LED



42025-5

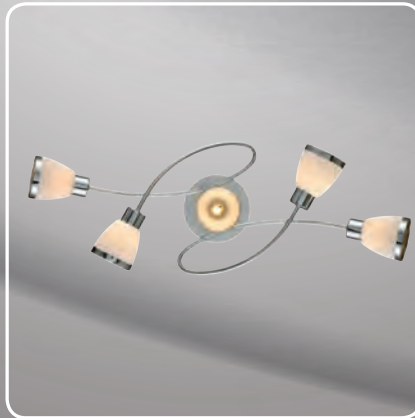

Chrom • Glas
chrome • glass
chrome • verre

33W  G9 230V

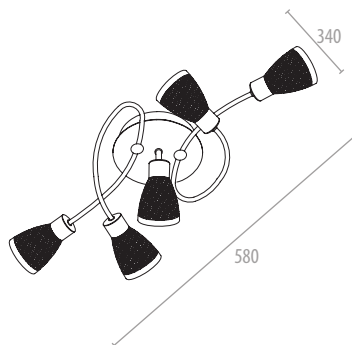

42025-5

↑ 190 • 580 x 340 • VE/PU: 4
5 x 33 W • G9 • 230V

A++ bis E



GINA, CAROLINA



998057-6



742010-6

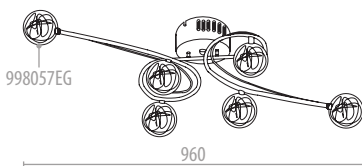

998057-6
960 x 495 x 220 - VE/PU: 1
6 x 20 W - G4 - 12V

A++ bis E



9 1003348 884845

GINA



Chrom • Glas
chrome • glass
chrome • verre

20W G4 12V

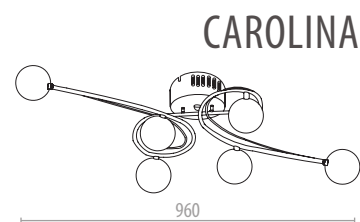

742010-6
960 x 495 x 220 - VE/PU: 4
incl. 6 x 2,5 W - G9 - 200lm - 3000K - A+
A+ 1200lm - 15 kWh/1000h - 230V



9 1003348 1157819

CAROLINA



tauschbar
changeable



Chrom • Acryl
chrome • acrylic
chrome • acrylique

incl. 2,5W G9 LED

Chrom • Acryl
chrome • acrylic
chrome • acrylique

incl. 2,5W G9 LED



742010-1
Ø 90 x 120 - VE/PU: 20
incl. 1 x 2,5 W - G9 - 200lm - 3000K - A+
A+ 200lm - 3 kWh/1000h - 230V

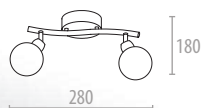

742011-2
280 x 180 - VE/PU: 4
incl. 2 x 2,5 W - G9 - 200lm - 3000K - A+
A+ 400lm - 5 kWh/1000h - 230V

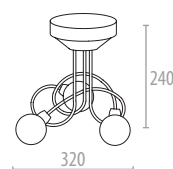

742010-3
Ø 320 x 240 - VE/PU: 8
incl. 3 x 2,5 W - G9 - 200lm - 3000K - A+
A+ 600lm - 8 kWh/1000h - 230V

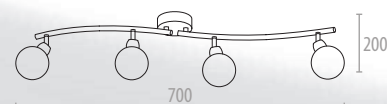

742011-4
700 x 200 - VE/PU: 4
incl. 4 x 2,5 W - G9 - 200lm - 3000K - A+
A+ 800lm - 10 kWh/1000h - 230V

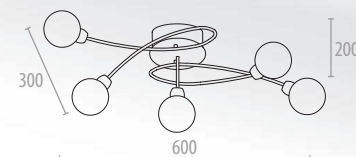

742010-5
600 x 300 x 200 - VE/PU: 6
incl. 5 x 2,5 W - G9 - 200lm - 3000K - A+
A+ 1000lm - 13 kWh/1000h - 230V



742010-3

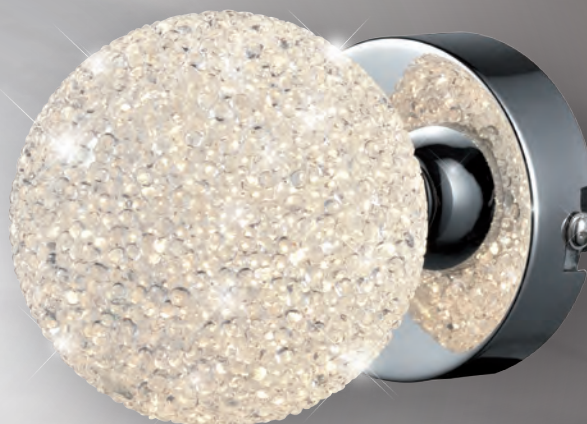

742010-1



742010-5

LED
tauschbar
↔
changeable



742011-4



742011-2



740098-6



740098-3



740098-1

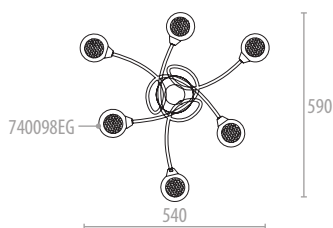

740098-6

160 x 540 x 590 - VE/PU: 1
6 x 28 W - G9 - 230V

A++ bis E

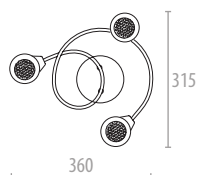

740098-3

360 x 315 x 145 - VE/PU: 12
3 x 28 W - G9 - 230V

A++ bis E

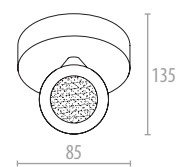

740098-1

Ø 85 - ↓ 135 - VE/PU: 24
1 x 28 W - G9 - 230V

A++ bis E



28W G9 230V



740098-4



740098-2



700

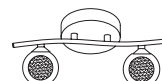

380

740098-4

700 x 160 x 170 - VE/PU: 1
4 x 28 W • G9 • 230V

A++ bis E



9 1003348 1119190

740098-2

↔ 380 • VE/PU: 12
2 x 28 W • G9 • 230V

A++ bis E



9 1003348 1119176



Chrom • Glas
chrome • glass
chrome • verre

28W  G9 230V



60750-1



60750-3



60750-2

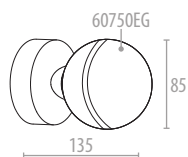

60750-1
Ø 85 x 135 • VE/PU: 24
1 x 33 W • G9 • 230V

A++ bis E



9 003348 112870

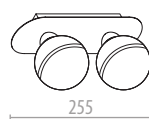

60750-2
255 x 85 x 135 • VE/PU: 12
2 x 33 W • G9 • 230V

A++ bis E



9 003348 112887

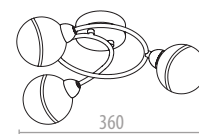

60750-3
360 x 315 x 145 • VE/PU: 12
3 x 33 W • G9 • 230V

A++ bis E



9 003348 112894

Chrom • Glas
chrome • glass
chrome • verre

33W G9 230V



60750-6



60750-5

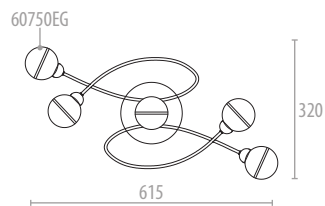

60750-5

615 x 320 x 230 - VE/PU: 6
5 x 33 W - G9 - 230V

A++ bis E



9 003348 112924

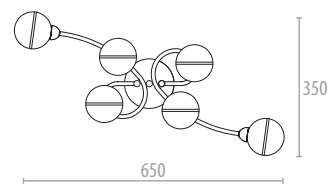

60750-6

650 x 350 x 190 - VE/PU: 6
6 x 33 W - G9 - 230V

A++ bis E



9 003348 112931



Chrom • Glas
chrome • glass
chrome • verre

33W  G9 230V

Stahl gebürstet • Chrom • Glas
metal brushed • chrome • glass
métal brossé • chrome • verre

28W  G9 230V



980074-1

Ø 110 x 130 - VE/PU: 24
1 x 28 W - G9 - 230V

A++ bis E



910033481899573

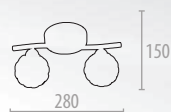

980074-2

↔ 280 x 150 - VE/PU: 12
2 x 28 W - G9 - 230V

A++ bis E



910033481899580

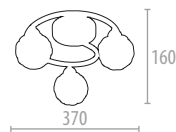

980074-3

Ø 370 - ↑ 160 - VE/PU: 12
3 x 28 W - G9 - 230V

A++ bis E



910033481899597

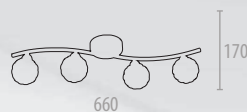

980074-4

↔ 660 - VE/PU: 8
4 x 28 W - G9 - 230V

A++ bis E



910033481899603



980074-1



980074-3



980074-4



980074-2



980079-4



980079-2



980079-1

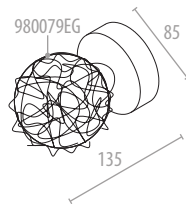

980079-1
Ø 85 • ↑ 135 • VE/PU: 24
1 x 42 W • G9 • 230V

A++ bis E



9 100334 810401 1

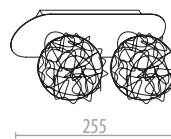

980079-2
85 x 255 • VE/PU: 12
2 x 42 W • G9 • 230V

A++ bis E



9 100334 810402 8

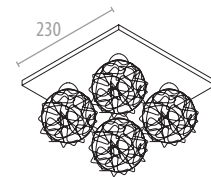

980079-4
230 x 230 • VE/PU: 1
4 x 42 W • G9 • 230V

A++ bis E



9 100334 810404 2

Chrom • Glas • Aluminium
chrome • glass • aluminium
chrome • verre • aluminium

42W G9 230V



980079-6



980079-3

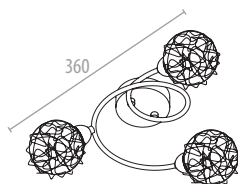

980079-3

320 x 360 • VE/PU: 12
3 x 42 W • G9 • 230V

A++ bis E



9 003348 104035

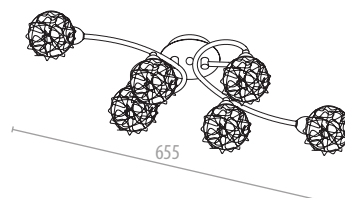

980079-6

655 x 350 • VE/PU: 6
6 x 42 W • G9 • 230V

A++ bis E



9 003348 105674



Chrom • Glas • Aluminium
chrome • glass • aluminium
chrome • verre • aluminium

42W  G9 230V



998040-5



998040-3

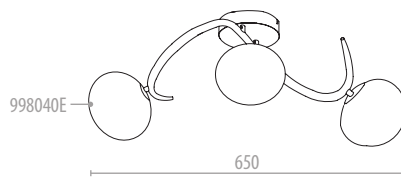

998040-3

650 x 500 - VE/PU: 4
3 x 40 W - E27 - 230V

A++ bis E



9 10033481845563

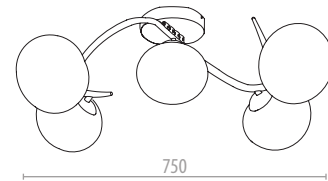

998040-5

750 x 500 - VE/PU: 4
5 x 40 W - E27 - 230V

A++ bis E



9 10033481845570

Stahl gebürstet • Chrom • Glas
metal brushed • chrome • glass
métal brossé • chrome • verre

40W E27 230V



998039-3

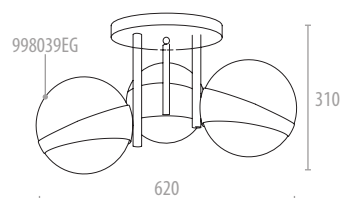

998039-3

Ø 620 • ↑ 310 • VE/PU: 2
3 x 60 W • E27 • 230V

A++ bis E



Chrom • Glas
chrome • glas
chrome • verre

60W		E27	230V
type: A45, Ø45, ↔ 75mm			
Tropfen • drop • goutte			



53698-2



Chrom • Glas
chrome • glass
chrome • verre

40W E14 230V

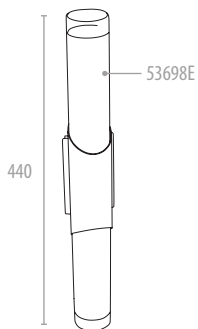

53698-2

↔ 440 - VE/PU: 12
2 x 40 W - E14 - 230V

A++ bis E



9 100334 818260 671



744000-2

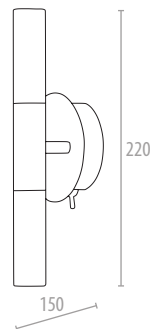

744000-2

220 x 85 x 150 - VE/PU: 16
incl. 2 x 3 W - COB-LED - 240lm - 3000K - A+

A+ 480lm - 6 kWh/1000h - 230V



9 003348 111099 9



Chrom • Acryl
chrome • acrylic
chrome • acrylique





745043-1



Chrom • Acryl
chrome • acrylic
chrome • acrylique

745043-1

300 x 80 x 75 • VE/PU: 12
incl. 1 x 5 W • SMD-LED • 400lm • 3000K • A+

A⁺ 400lm • 5 kWh/1000h • 230V



9 003348 126600



incl. SMD LED



994800



994801

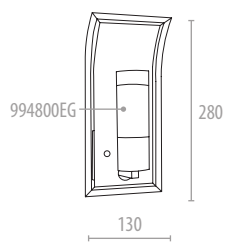

994800
130 x 280 • VE/PU: 6
1 x 40 W • E14 • 230V
Chrom • Glas
chrome • glass
chrome • verre

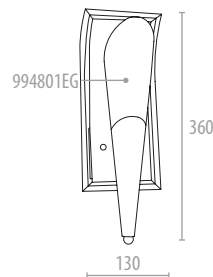

994801
130 x 360 • VE/PU: 6
1 x 40 W • E14 • 230V
Stahl gebürstet • Glas
metal brushed • glass
métal brossé • verre





745041

745040

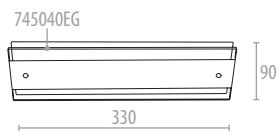

745040

330 x 60 x 90 • VE/PU: 12
incl. 1 x 4 W • SMD-LED • 320lm • 3000K • A+

A+ 320lm • 4 kWh/1000h • 230V



9 003348 124026

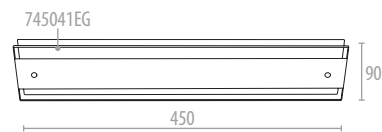

745041

450 x 60 x 90 • VE/PU: 10
incl. 1 x 6 W • SMD-LED • 480lm • 3000K • A+

A+ 480lm • 6 kWh/1000h • 230V



9 003348 124033



Stahl gebürstet • Glas
metal brushed • glass
métal brossé • verre

incl. SMD LED



745010



745011



745012

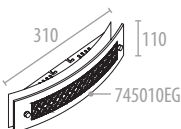

745010
310 x 110 x 75 • VE/PU: 10
incl. 1 x 10 W • SMD-LED
700lm • 4000K • A+

A+ 700lm
10 kWh/1000h • 230V



9 400334 811393 8

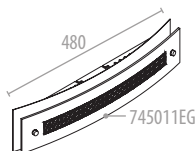

745011
480 x 110 x 75 • VE/PU: 10
incl. 1 x 15 W • SMD-LED
1050lm • 4000K • A+

A+ 1050lm
15 kWh/1000h • 230V



9 400334 811394 5

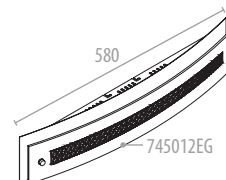

745012
580 x 110 x 75 • VE/PU: 6
incl. 1 x 21 W • SMD-LED
1450lm • 4000K • A+

A+ 1450lm
21 kWh/1000h • 230V



9 400334 811395 2



Chrom • Glas
chrome • glass
chrome • verre

incl. SMD LED



745050



745051



745052

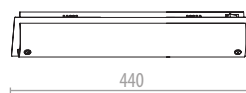
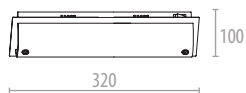

Chrom • Acryl
chrome • acrylic
chrome • acrylique

745050
320 x 100 x 70 - VE/PU: 12
incl. 1 x 6 W - SMD-LED • 480lm • 3000K • A+
A+ 480lm • 6 kWh/1000h • 230V

745051
440 x 100 x 70 - VE/PU: 8
incl. 1 x 8 W - SMD-LED • 640lm • 3000K • A+
A+ 640lm • 8 kWh/1000h • 230V

745052
600 x 100 x 70 - VE/PU: 8
incl. 1 x 12 W - SMD-LED • 960lm • 3000K • A+
A+ 960lm • 12 kWh/1000h • 230V

incl. SMD LED



9 003348 1154955



9 003348 1154962



9 003348 1154979





994702



994701



994700

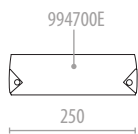

994700

↑ 250 - VE/PU: 10
1 x 40 W - E14 - 230V

A++ bis E



9 003348 834963

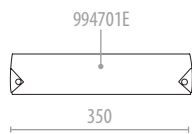

994701

↑ 350 - VE/PU: 10
2 x 40 W - E14 - 230V

A++ bis E



9 003348 834956

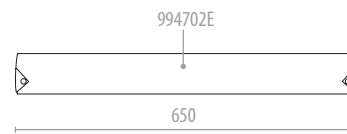

994702

↑ 650 - VE/PU: 10
4 x 40 W - E14 - 230V

A++ bis E



9 003348 834949



Chrom • Glas
chrome • glass
chrome • verre





745045

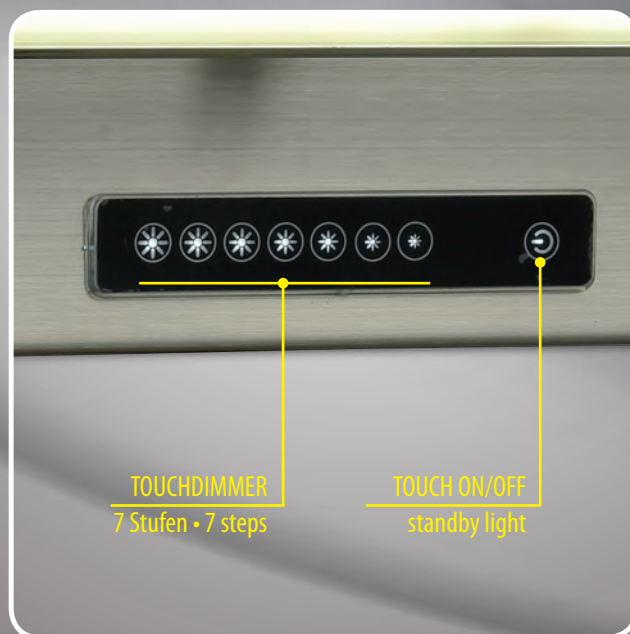

TOUCHDIMMER
7 Stufen • 7 steps

TOUCH ON/OFF
standby light

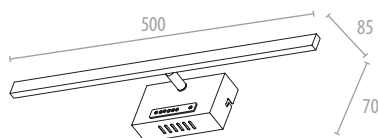

745045

500 x 70 x 85 • VE/PU: 8
incl. 1 x 12 W • SMD-LED • 960lm • 3000K • A+

A+ 960lm • 12 kWh/1000h • 230V



9 003348 1156966

Stahl gebürstet • Chrom • Acryl
metal brushed • chrome • acrylic
métal brossé • chrome • acrylique

incl. SMD LED

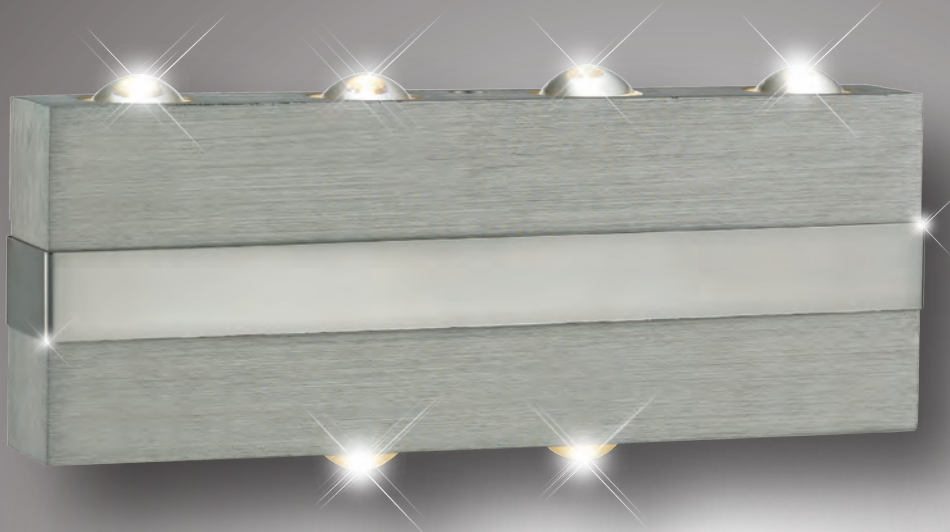

745035



745034

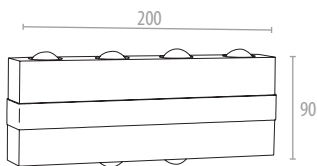

745035

200 x 30 x 90 - VE/PU: 24
incl. 6 x 1 W - High-Power-LED - 85lm - 3000K - A+

A+ 510lm - 6 kWh/1000h - 230V



9 003348 113068

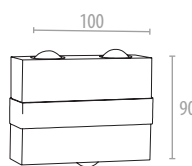

745034

100 x 30 x 90 - VE/PU: 24
incl. 3 x 1 W - High-Power-LED - 85lm - 3000K - A+

A+ 255lm - 3 kWh/1000h - 230V



9 003348 110640



Aluminium gebürstet • Chrom
aluminium brushed • chrome
aluminium brossé • chrome



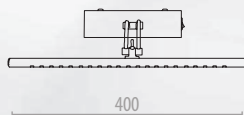

749005 
↔ 400 - VE/PU: 12
incl. 1 x 4 W - SMD-LED - 320lm - 3000K - A+
Chrom
chrome
chrome

A+ 320lm - 4 kWh/1000h - 230V



749007 
↔ 400 - VE/PU: 12
incl. 1 x 4 W - SMD-LED - 320lm - 3000K - A+
Stahl gebürstet
metal brushed
métal brossé

A+ 320lm - 4 kWh/1000h - 230V



749010 
↔ 400 - VE/PU: 12
incl. 1 x 4 W - SMD-LED - 320lm - 3000K - A+
Messing
brass
laiton

A+ 320lm - 4 kWh/1000h - 230V

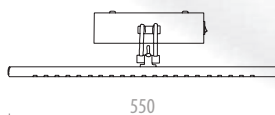

749006 
↔ 550 - VE/PU: 12
incl. 1 x 8 W - SMD-LED - 640lm - 3000K - A+
Chrom
chrome
chrome

A+ 640lm - 8 kWh/1000h - 230V



749006



PICTURE LIGHT LED



749005



749007



749010



04

Spot-Leuchten spotlights spots

JARON	03
MAGIC	05
JOY	07
NERO	09
CORSO	11
SQUARE	13
SEMIC	15
BRAVO	17
MICON	19
PRINCE	21
KING	23
COLORSTAR	25
WAVER	27
RUBY	29
VERUS	31
LYRIC	33
PAVO	35
VERENA	37
CLIVIA	39
LIANA	41
MODUS	43
ELVO	45
UFO LED	47

Chrom • Glas
chrome • glass
chrome • verre

40W - E14 230V



60018-1
Ø 100 • ↑ 165 • VE/PU: 24
1 x 40 W • E14 • 230V

A++ bis E



9 003348 158632

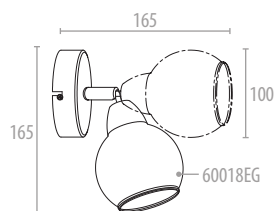

60018-2
↔ 300 • ↑ 195 • VE/PU: 12
2 x 40 W • E14 • 230V

A++ bis E



9 003348 158649

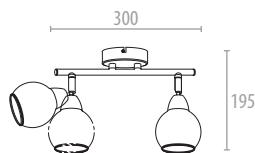

60018-3
↔ 450 • ↑ 195 • VE/PU: 8
3 x 40 W • E14 • 230V

A++ bis E



9 003348 158656

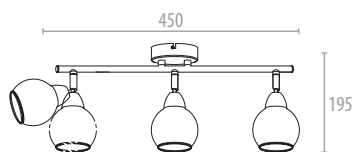

60018-4
↔ 800 • ↑ 195 • VE/PU: 8
4 x 40 W • E14 • 230V

A++ bis E



9 003348 158663

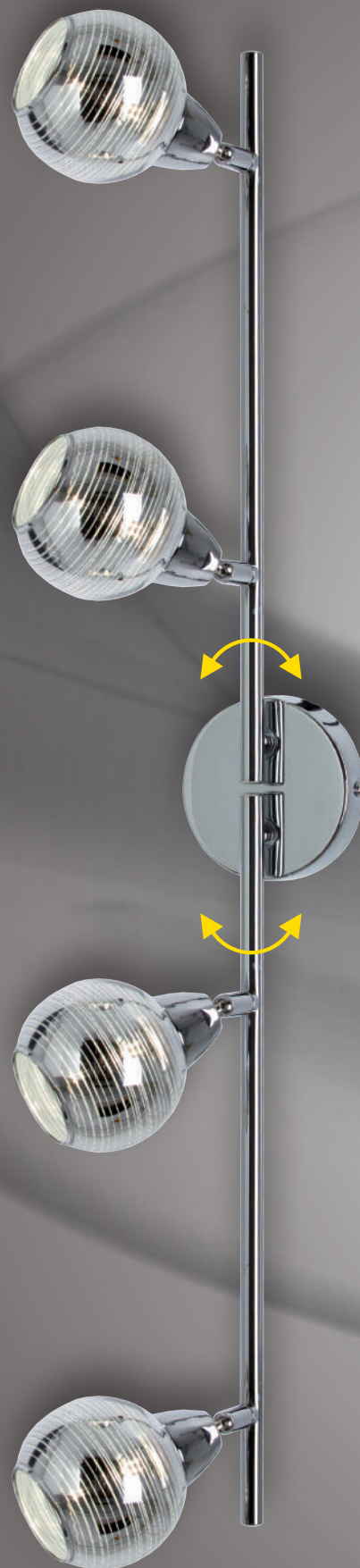
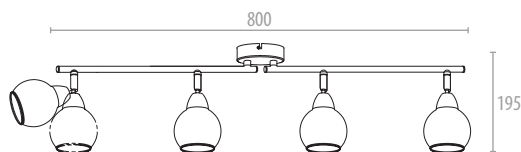

60018-4



Chrom • Glas
chrome • glass
chrome • verre

incl. 3,5W  G9 LED 230V



760017-1

90 x 150 x 130 - VE/PU: 20
1 x 3,5 W - G9 - 320lm - 3000K - A++

A++ 320lm • 4 kWh/1000h • 230V

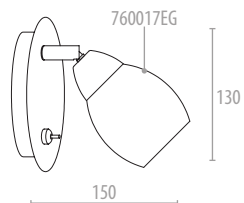

760017-2

410 x 90 x 190 - VE/PU: 10
2 x 3,5 W - G9 - 320lm - 3000K - A++

A++ 640lm • 7 kWh/1000h • 230V

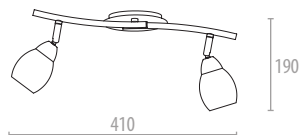

760017-3

Ø 290 x 190 - VE/PU: 10
3 x 3,5 W - G9 - 320lm - 3000K - A++

A++ 960lm • 11 kWh/1000h • 230V

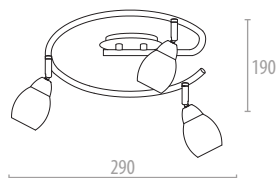

760017-4

820 x 90 x 190 - VE/PU: 10
4 x 3,5 W - G9 - 320lm - 3000K - A++

A++ 1280lm • 14 kWh/1000h • 230V

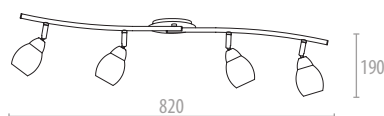

760017-4





tauschbar
↔
changeable



760017-3



760017-2



760017-1

Chrom • Kunststoff
chrome • plastic
chrome • plastique

incl. SMD LED



762044-1

Ø 95 • ↑ 110 • VE/PU: 12
incl. 1 x 4 W • SMD-LED • 350lm • 3000K • A+

A+ 350lm • 4 kWh/1000h • 230V

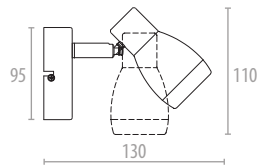

762044-2

↔ 365 • ↓ 155 • VE/PU: 6
incl. 2 x 4 W • SMD-LED • 350lm • 3000K • A+

A+ 700lm • 8 kWh/1000h • 230V

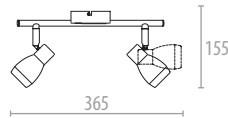

762044-3

↔ 565 • ↓ 155 • VE/PU: 6
incl. 3 x 4 W • SMD-LED • 350lm • 3000K • A+

A+ 1050lm • 12 kWh/1000h • 230V

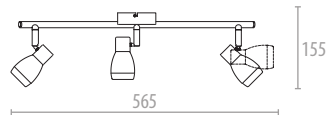

762044-4

↔ 830 • ↓ 170 • VE/PU: 8
incl. 4 x 4 W • SMD-LED • 350lm • 3000K • A+

A+ 1400lm • 16 kWh/1000h • 230V

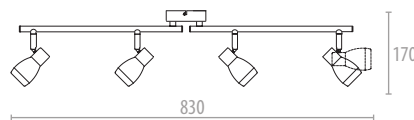

762044-6

l=1800 max • VE/PU: 4
incl. 6 x 4 W • SMD-LED • 350lm • 3000K • A+

A+ 2100lm • 24 kWh/1000h • 230V

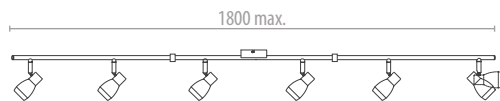

762044-6





762044-4



762044-3



762044-2



762044-1



„JOY“ Serie • series • séries



6.34

Stahl gebürstet • Chrom • Acryl
metal brushed • chrome • acrylic
métal brossé • chrome • acrylique

incl. SMD LED



DIMMABLE

762027-1

↑ 160 • ↔ 100 • VE/PU: 12

incl. 1 x 5 W • SMD-LED • 320lm • 3000K • A+

A+ → 320lm • 5 kWh/1000h • 230V

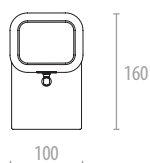

762027-2

↑ 175 • ↔ 430 • VE/PU: 8

incl. 2 x 5 W • SMD-LED • 320lm • 3000K • A+

A+ → 640lm • 10 kWh/1000h • 230V

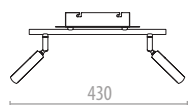

762027-3

↑ 175 • ↔ 570 • VE/PU: 6

incl. 3 x 5 W • SMD-LED • 320lm • 3000K • A+

A+ → 960lm • 15 kWh/1000h • 230V

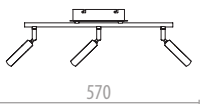

762027-4

↑ 180 • ↔ 890 • VE/PU: 6

incl. 4 x 5 W • SMD-LED • 320lm • 3000K • A+

A+ → 1280lm • 20 kWh/1000h • 230V

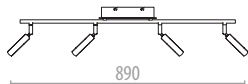

762027-6

↑ 190 • ↔ 1700 • VE/PU: 4

incl. 6 x 5 W • SMD-LED • 320lm • 3000K • A+

A+ → 1920lm • 30 kWh/1000h • 230V

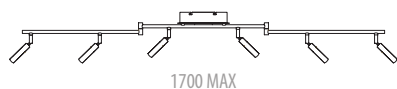

762027-6



DIMMABLE

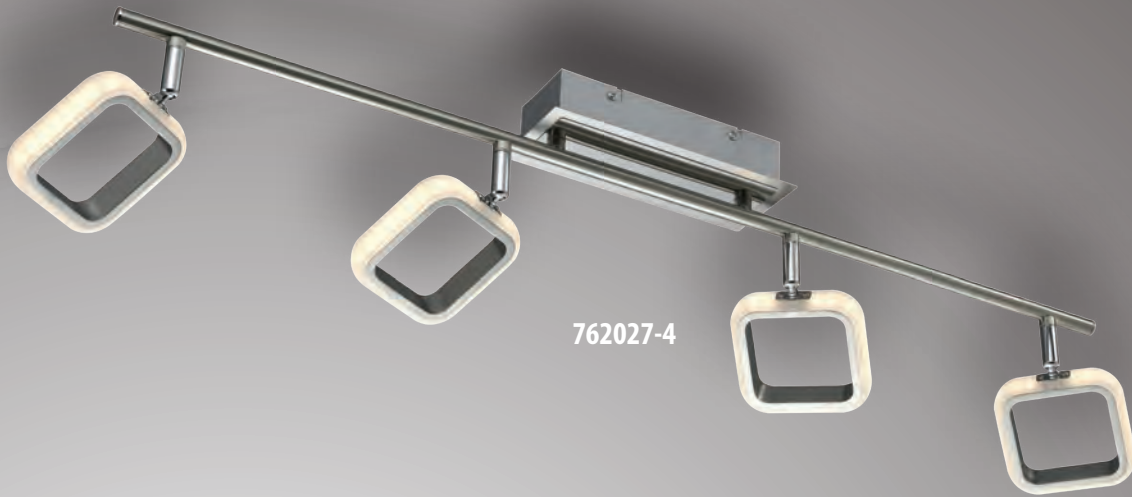

762027-4



762027-3



762027-2



762027-1

Stahl gebürstet • Chrom • Glas
metal brushed • chrome • glass
métal brossé • chrome • verre

incl. SMD  LED



762026-4

685 x 80 • ↓ 1200 - VE/PU: 4
incl. 4 x 6 W • SMD-LED • 480lm • 3000K • A+

A+ → 1920lm • 24 kWh/1000h • 230V

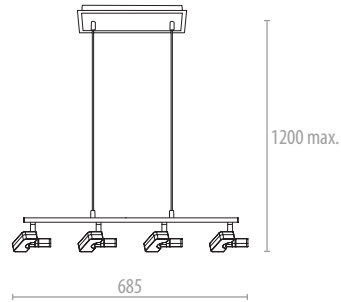

762029-1

100 x 100 x 110 - VE/PU: 20
incl. 1 x 6 W • SMD-Led • 480lm • 3000K • A+

A+ → 480lm • 6 kWh/1000h • 230V

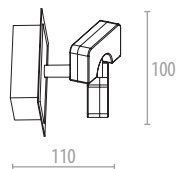

762029-2

110 x 80 x 300 - VE/PU: 10
incl. 2 x 6 W • SMD-Led • 480lm • 3000K • A+

A+ → 960lm • 12 kWh/1000h • 230V

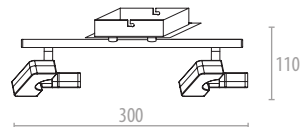

762029-3

110 x 80 x 480 - VE/PU: 10
incl. 3 x 6 W • SMD-Led • 480lm • 3000K • A+

A+ → 1440lm • 18 kWh/1000h • 230V

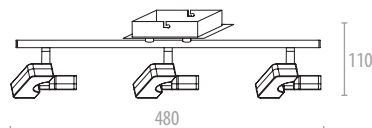

762029-4

110 x 80 x 850 - VE/PU: 6
incl. 4 x 6 W • SMD-Led • 480lm • 3000K • A+

A+ → 1920lm • 24 kWh/1000h • 230V

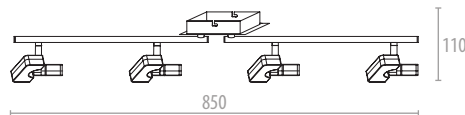

762029-6

110 x 80 x 1800 - VE/PU: 6
incl. 6 x 6 W • SMD-Led • 480lm • 3000K • A+

A+ → 2880lm • 36 kWh/1000h • 230V

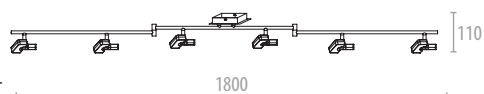

762029-6



762026-4

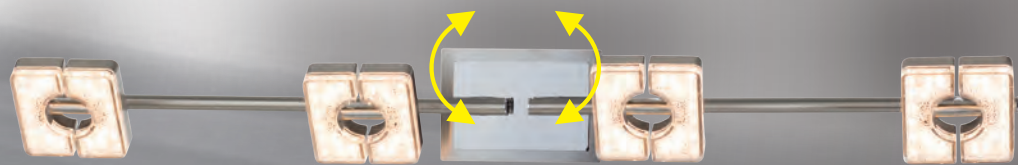

762029-4



762029-3



762029-2



762029-1

Stahl gebürstet • Chrom • Acryl
metal brushed • chrome • acrylic
métal brossé • chrome • acrylique

incl. SMD LED



762020-1

100 x 100 x 110 - VE/PU: 20
incl. 1 x 6 W - SMD-LED
480lm - 3000K - A+

A+ 480lm

6 kWh/1000h - 230V

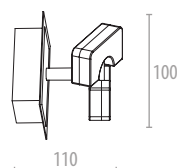

762020-2

110 x 80 x 300 - VE/PU: 10
incl. 2 x 6 W - SMD-LED
480lm - 3000K - A+

A+ 960lm

12 kWh/1000h - 230V

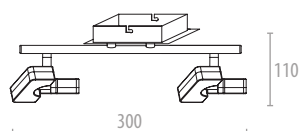

762020-3

110 x 80 x 480 - VE/PU: 10
incl. 3 x 6 W - SMD-LED
480lm - 3000K - A+

A+ 1440lm

18 kWh/1000h - 230V

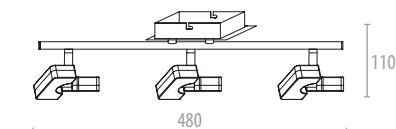

762020-4

110 x 80 x 850 - VE/PU: 6
incl. 4 x 6 W - SMD-LED
480lm - 3000K - A+

A+ 1920lm

24 kWh/1000h - 230V

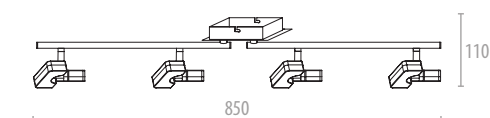

762020-6

110 x 80 x 1800 - VE/PU: 6
incl. 6 x 6 W - SMD-LED
480lm - 3000K - A+

A+ 2880lm

36 kWh/1000h - 230V

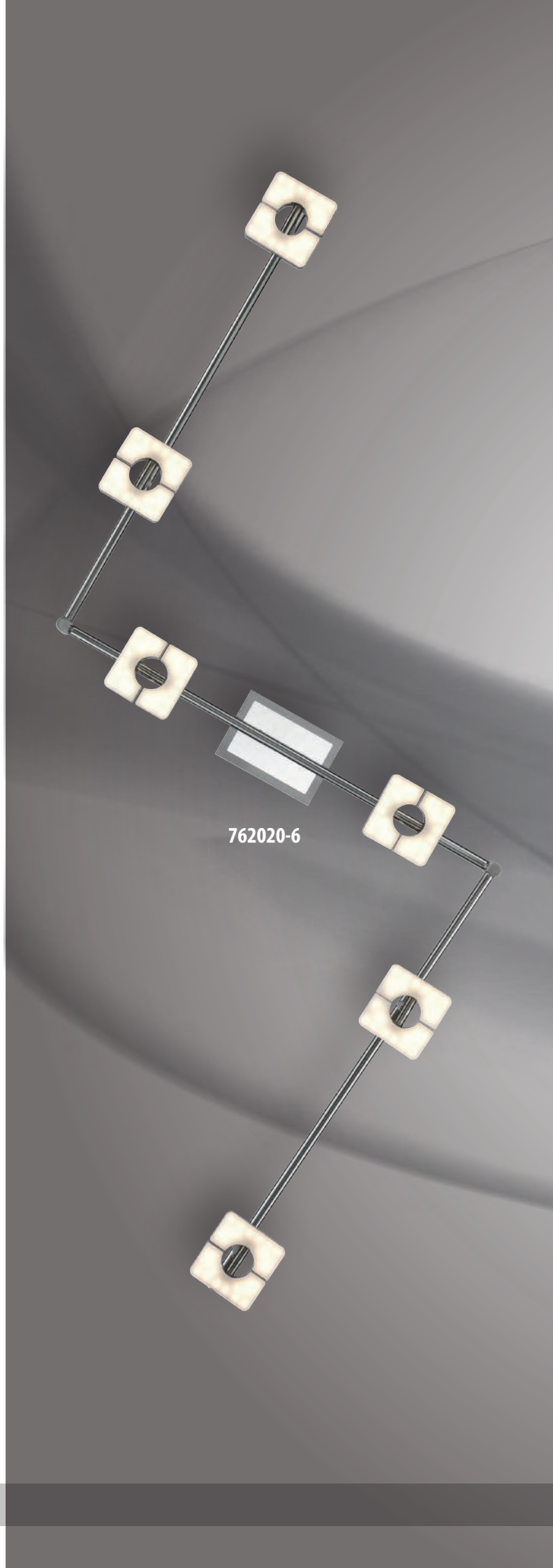
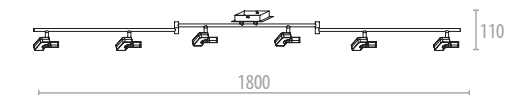

762020-6

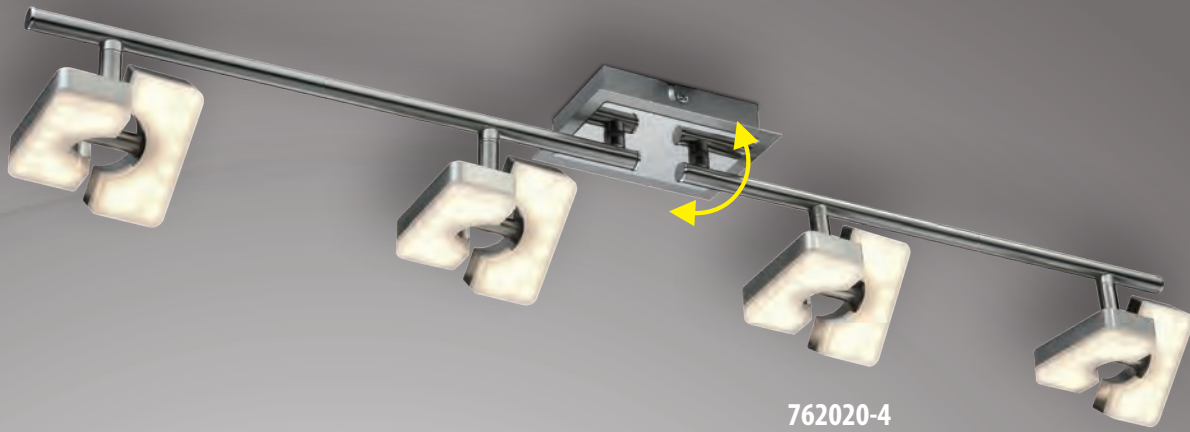

762020-4

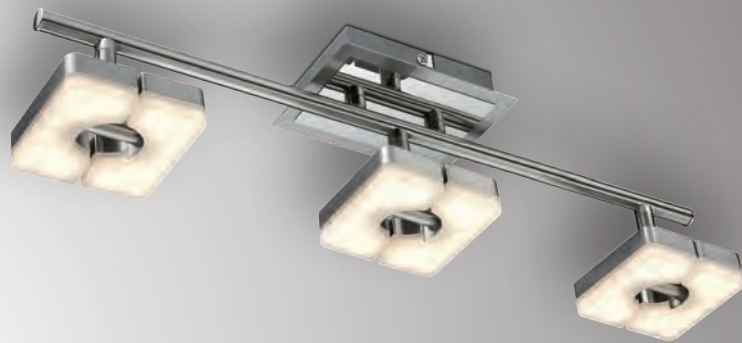

762020-3



762020-2



762020-1

Chrom • Acryl
chrome • acrylic
chrome • acrylique

incl. SMD LED



762040-1

Ø 92 • VE/PU: 12
incl. 1 x 6 W • SMD-LED • 480lm • 3000K • A+

A+ 480lm • 6 kWh/1000h • 230V

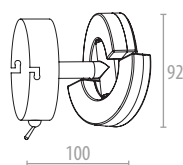

762040-2

↔ 305 • VE/PU: 8
incl. 2 x 6 W • SMD-LED • 480lm • 3000K • A+

A+ 960lm • 12 kWh/1000h • 230V

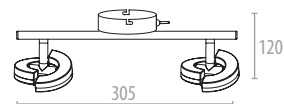

762040-3

↔ 480 • VE/PU: 8
incl. 3 x 6 W • SMD-LED • 480lm • 3000K • A+

A+ 1440lm • 18 kWh/1000h • 230V

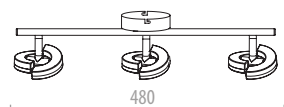

762040-4

↔ 780 • VE/PU: 6
incl. 4 x 6 W • SMD-LED • 480lm • 3000K • A+

A+ 1920lm • 24 kWh/1000h • 230V

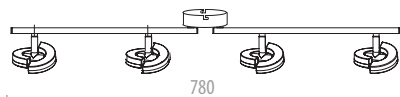

762040-6

↔ 1800 • VE/PU: 4
incl. 6 x 6 W • SMD-LED • 480lm • 3000K • A+

A+ 2880lm • 36 kWh/1000h • 230V

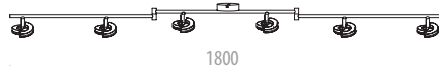

762040-6



762040-4



762040-3



762040-2



762040-1

Chrom • Acryl
chrome • acrylic
chrome • acrylique

incl. SMD LED



762049-1

↔ 100 • ↑ 100 - VE/PU: 12
incl. 1 x 6 W - SMD-LED - 480lm - 3000K - A+

A+ 480lm • 6 kWh/1000h • 230V



9 1003348 141351

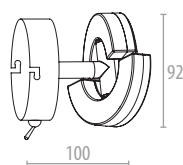

762049-2

↔ 300 • ↑ 110 - VE/PU: 8
incl. 2 x 6 W - SMD-LED - 480lm - 3000K - A+

A+ 960lm • 12 kWh/1000h • 230V



9 1003348 141368

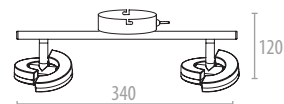

762049-3

↔ 480 • ↑ 110 - VE/PU: 8
incl. 3 x 6 W - SMD-LED - 480lm - 3000K - A+

A+ 1440lm • 18 kWh/1000h • 230V



9 1003348 141375

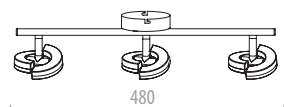

762049-4

↔ 780 • ↑ 110 - VE/PU: 6
incl. 4 x 6 W - SMD-LED - 480lm - 3000K - A+

A+ 1920lm • 24 kWh/1000h • 230V



9 1003348 141382

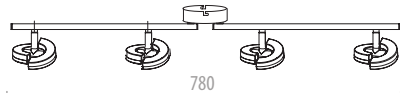

762049-6

↔ 1800 • ↑ 110 - VE/PU: 4
incl. 6 x 6 W - SMD-LED - 480lm - 3000K - A+

A+ 2880lm • 36 kWh/1000h • 230V



9 1003348 141399

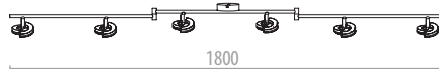

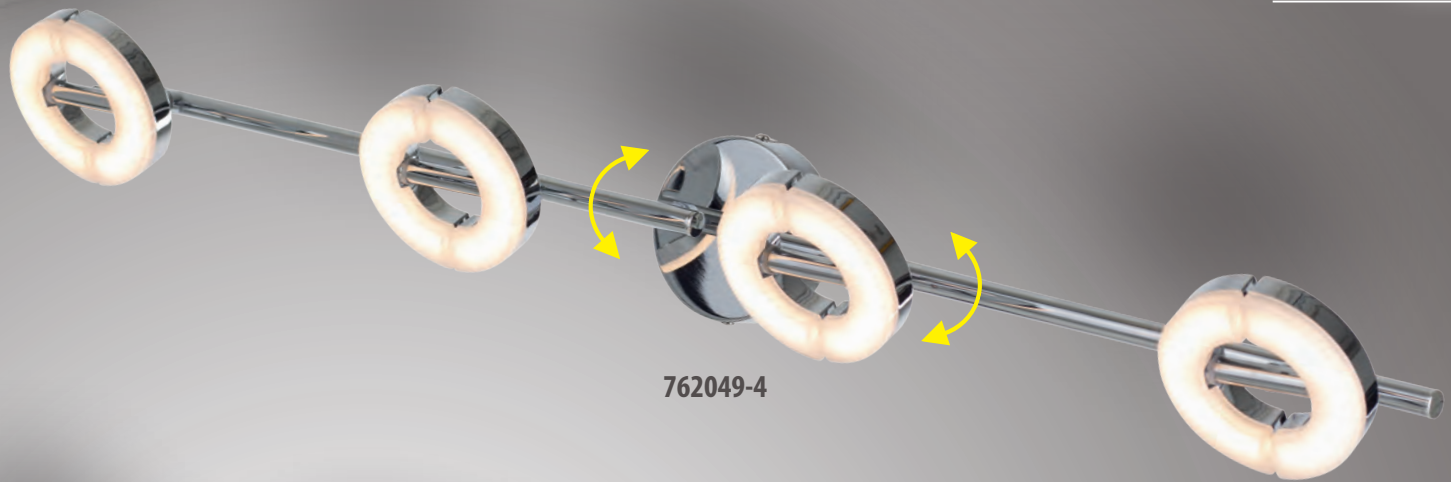

762049-4



762049-3

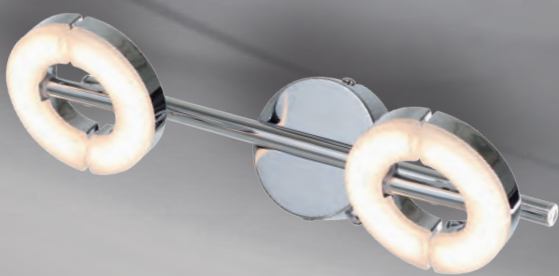

762049-2

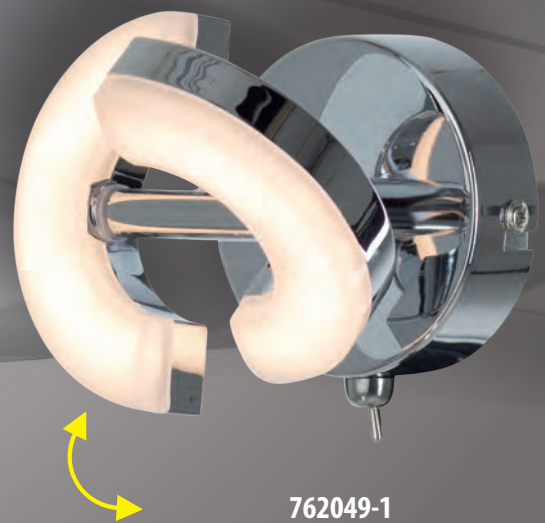

762049-1

Metall • Chrom • Acryl
metal • chrome • acrylic
métal • chrome • acrylique

incl. SMD LED



762017-1

Ø 80 • VE/PU: 20
incl. 1 x 4,5 W • SMD-LED • 350lm • 3000K • A+

A+ 350lm • 5 kWh/1000h • 230V



9 003348 154993

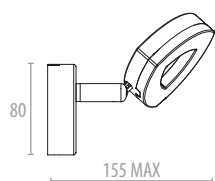

762017-2

↔ 300 • VE/PU: 10
incl. 2 x 4,5 W • SMD-LED • 350lm • 3000K • A+

A+ 700lm • 9 kWh/1000h • 230V



9 003348 155006

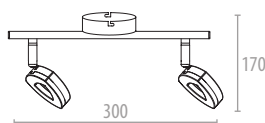

762017-3

↔ 480 • VE/PU: 10
incl. 3 x 4,5 W • SMD-LED • 350lm • 3000K • A+

A+ 1050lm • 14 kWh/1000h • 230V



9 003348 155013

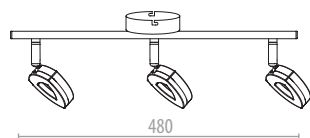

762017-4

↔ 780 • VE/PU: 8
incl. 4 x 4,5 W • SMD-LED • 350lm • 3000K • A+

A+ 1400lm • 18 kWh/1000h • 230V



9 003348 155037

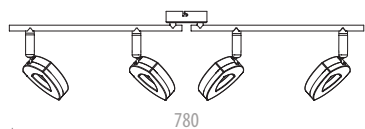

762017-6

↔ 1800 • VE/PU: 6
incl. 6 x 4,5 W • SMD-LED • 350lm • 3000K • A+

A+ 2100lm • 27 kWh/1000h • 230V



9 003348 155051

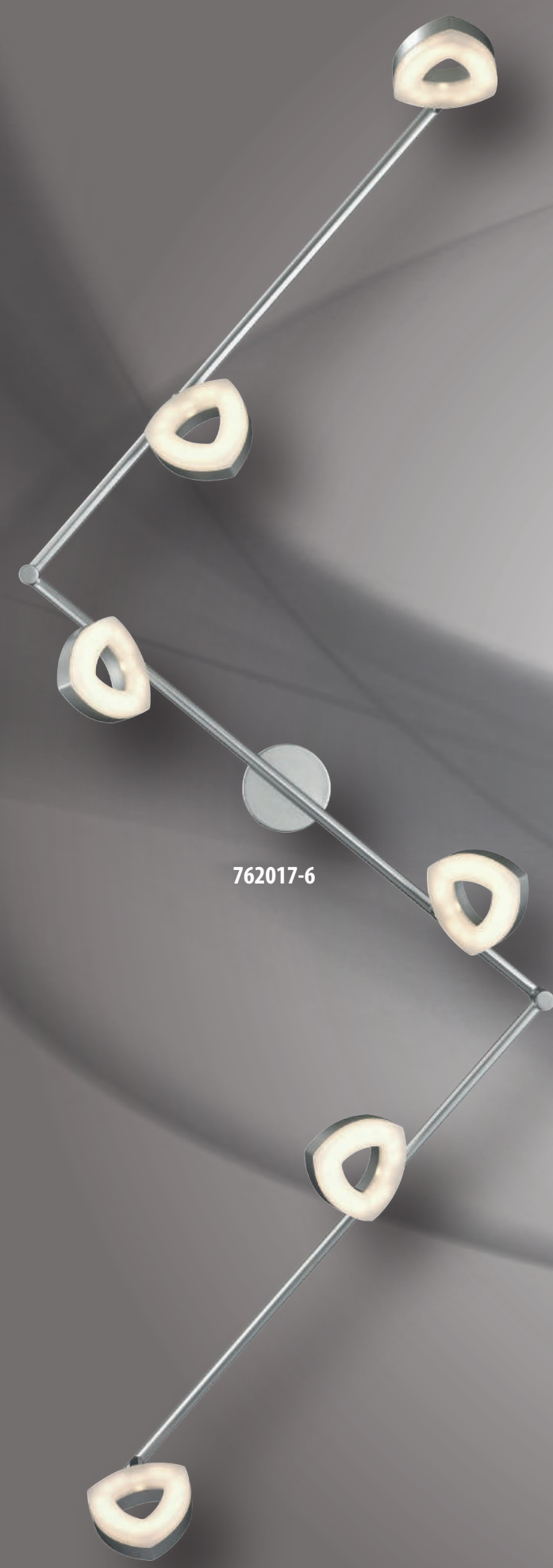
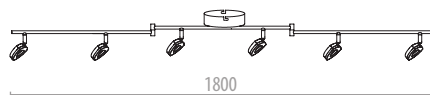

762017-6

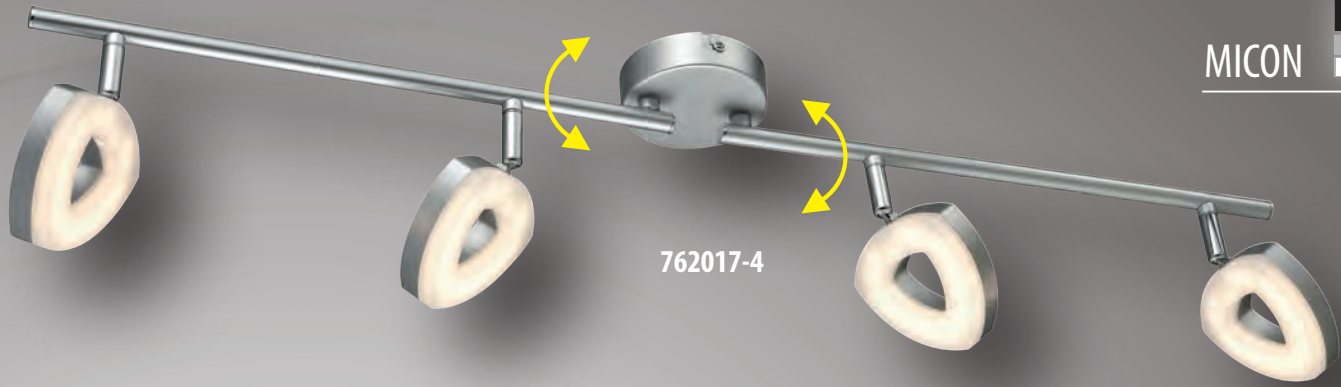

762017-4



762017-3



762017-2



762017-1

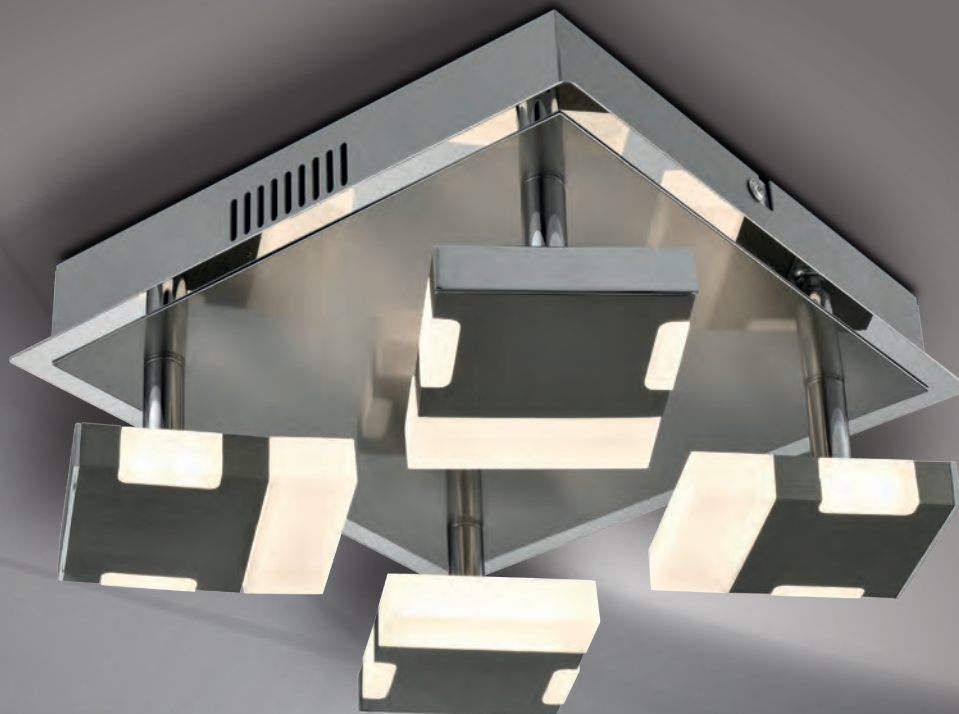

762036-4



762036-1

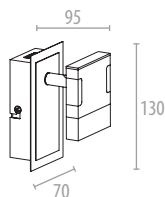

762036-1
70 x 130 x 95 • VE/PU: 24
incl. 1 x 5 W • SMD-LED • 400lm • 3000K • A+
A+ 400lm • 5 kWh/1000h • 230V



9 003 348 1 570 31

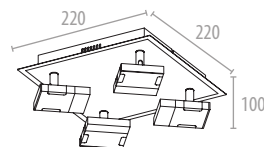

762036-4
220 x 220 x 100 • VE/PU: 5
incl. 4 x 5 W • SMD-LED • 400lm • 3000K • A+
A+ 1600lm • 20 kWh/1000h • 230V



9 003 348 1 570 62

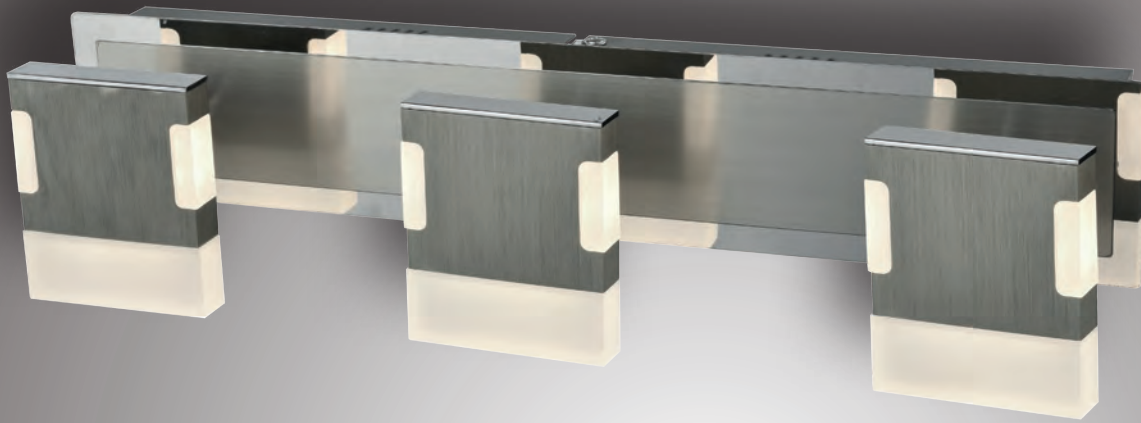

762036-3

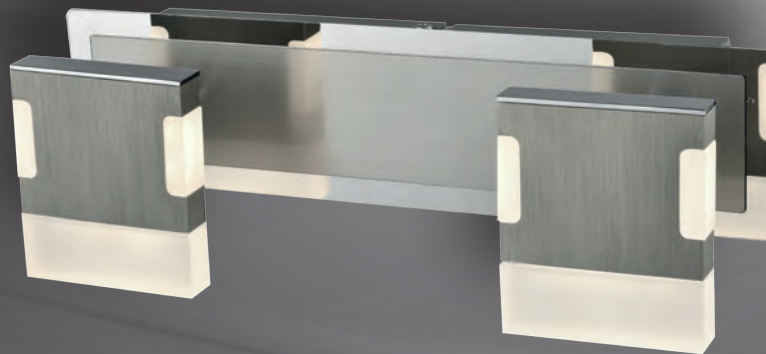

762036-2

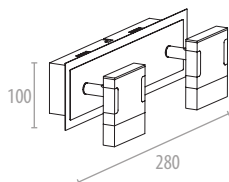

762036-2

280 x 70 x 100 • VE/PU: 12
incl. 2 x 5 W • SMD-LED • 400lm • 3000K • A+

A+ 800lm • 10 kWh/1000h • 230V



9 003 348 1157055

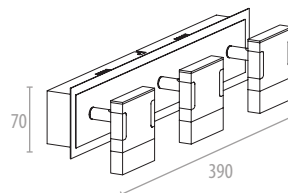

762036-3

390 x 70 x 100 • VE/PU: 8
incl. 3 x 5 W • SMD-LED • 400lm • 3000K • A+

A+ 1200lm • 15 kWh/1000h • 230V



9 003 348 1157048



Stahl gebürstet • Chrom • Acryl
metal brushed • chrome • acrylic
métal brossé • chrome • acrylique

incl. SMD LED

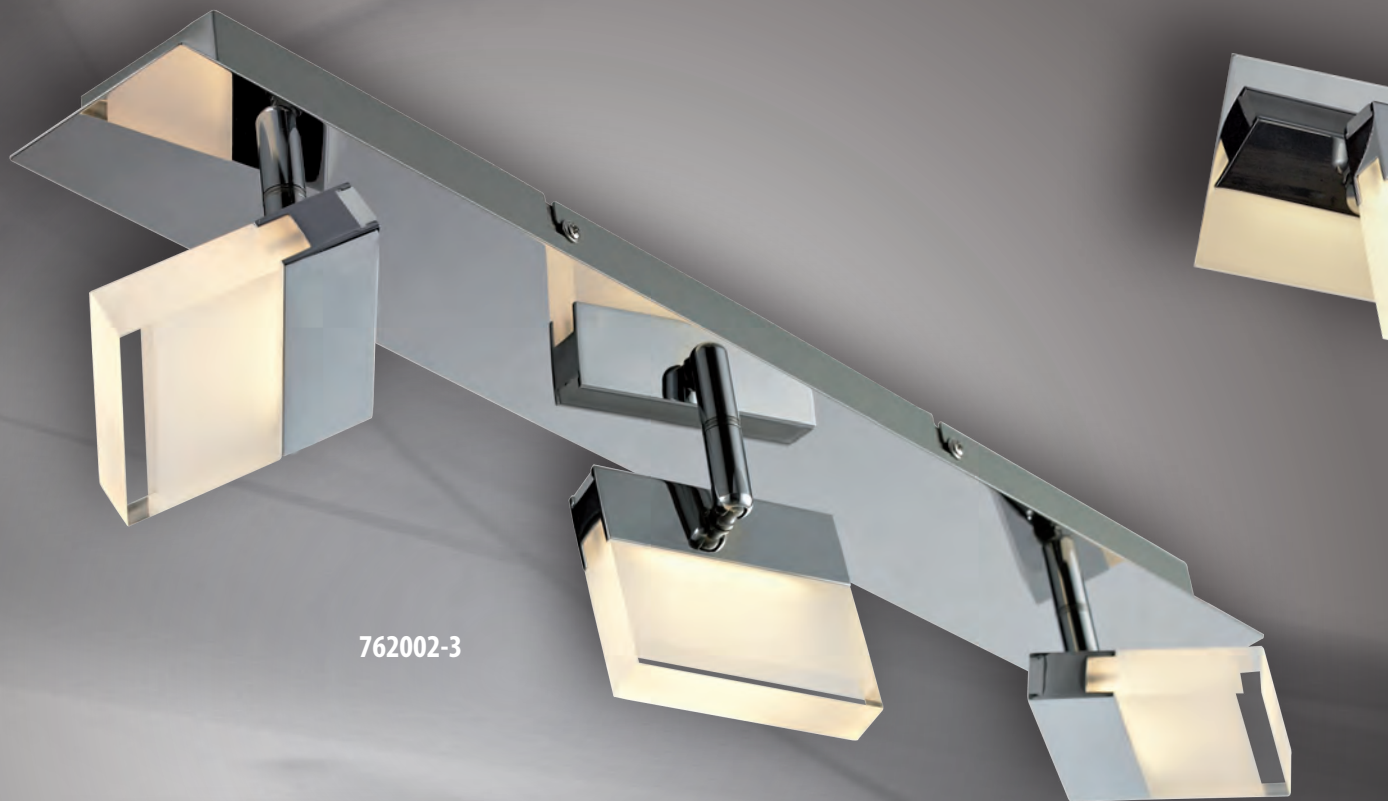

762002-3

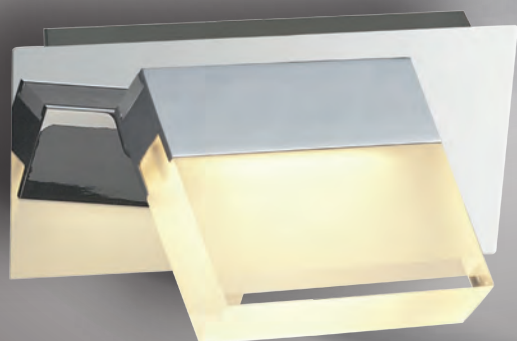

762002-1

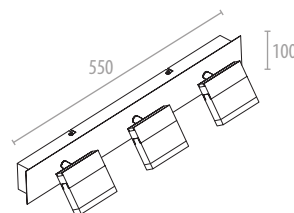
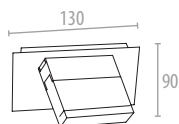

762002-1

90 x 130 x 90 - VE/PU: 12
incl. 1 x 4,5 W - SMD-LED - 360lm - 3000K - A+

A+ 360lm • 5 kWh/1000h • 230V



9 1003348 119220



762002-3

550 x 100 x 100 - VE/PU: 8
incl. 3 x 4,5 W - SMD-LED - 360lm - 3000K - A+

A+ 1080lm • 14 kWh/1000h • 230V



9 1003348 119244

Chrom • Acryl
chrome • acrylic
chrome • acrylique

incl. SMD LED

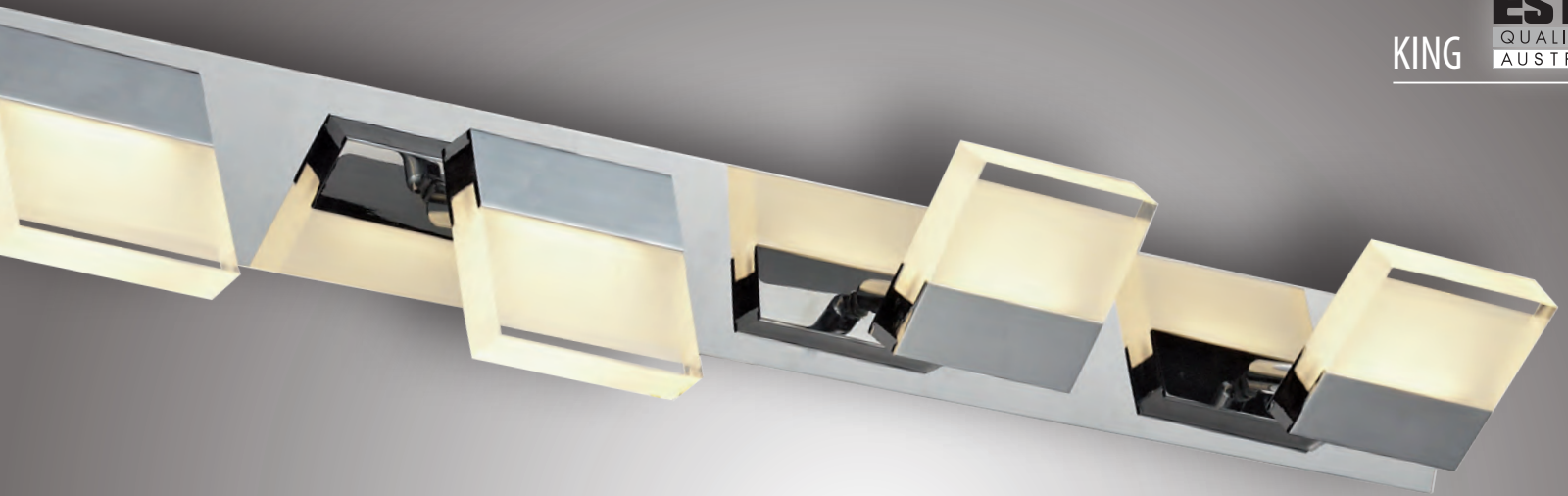

762002-4

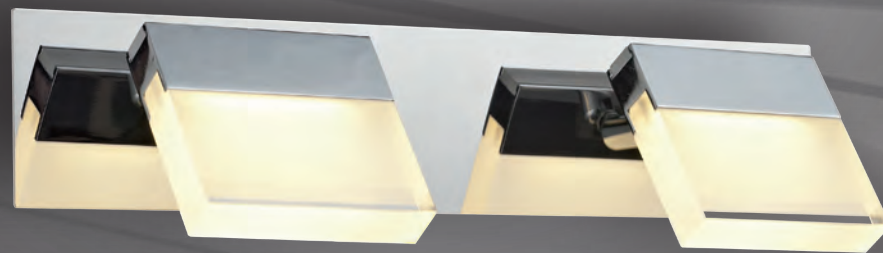

762002-2

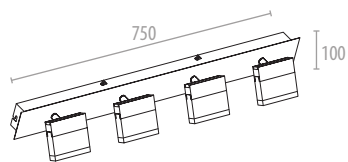

762002-4
750 x 100 x 100 - VE/PU: 6
incl. 4 x 4,5 W - SMD-LED - 365lm - 3000K - A+
A+ 1460lm - 18 kWh/1000h - 230V



9 1003348 111925 1

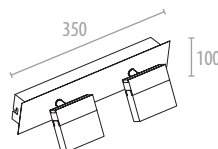

762002-2
350 x 100 x 100 - VE/PU: 12
incl. 2 x 4,5 W - SMD-LED - 360lm - 3000K - A+
A+ 720lm - 9 kWh/1000h - 230V



9 1003348 111923 7



Chrom • Acryl
chrome • acrylic
chrome • acrylique

incl. SMD LED



762043-4

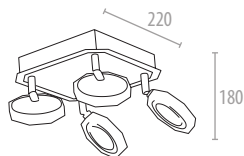
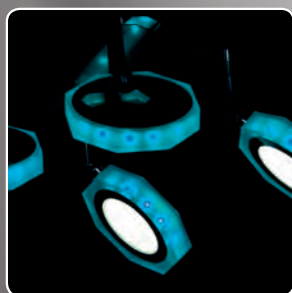

Stahl gebürstet • Chrom • Acryl
metal brushed • chrome • acrylic
métal brossé • chrome • acrylique

762043-4

220 x 220 x 180 - VE/PU: 8
incl. 4 x 3,6 W • SMD-LED • 288lm • 3000K • A+
incl. 4 x 2,2 W • RGB-LED • A+

A+ 1150lm • 23 kWh/1000h • 230V





762042-4

762042-3

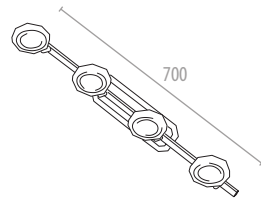
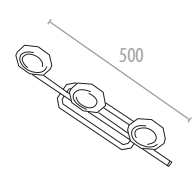

762042-3
500 x 95 x 200 - VE/PU: 8
incl. 3 x 3,6 W - SMD-LED - 288lm - 3000K - A+
incl. 3 x 2,2 W - RGB-LED - A+
A+ 860lm - 18 kWh/1000h - 230V



762042-4
700 x 95 x 200 - VE/PU: 8
incl. 4 x 3,6 W - SMD-LED - 288lm - 3000K - A+
incl. 4 x 2,2 W - RGB-LED - A+
A+ 1150lm - 23 kWh/1000h - 230V



Stahl gebürstet • Chrom • Acryl
metal brushed • chrome • acrylic
métal brossé • chrome • acrylique

incl. SMD LED

incl. RGB LED

Stahl gebürstet • Chrom • Acryl
metal brushed • chrome • acrylic
métal brossé • chrome • acrylique

incl. Board GU10 9W LED

LED tauschbar
changeable 3.000K
warm white



89584

TAUSCHBARES
LED - Board
changeable
LED

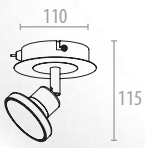

760044-1

↓ 115 • Ø 110 - VE/PU: 16
incl. 1 x 9W • GU10 • 700lm • 3000K • A+
A+ 700lm • 9 kWh/1000h • 230V

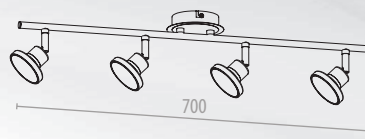

760044-4

↓ 145 • ↔ 700 x 110 - VE/PU: 8
incl. 4 x 9W • GU10 • 700lm • 3000K • A+
A+ 2800lm • 36 kWh/1000h • 230V

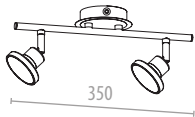

760044-2

↓ 145 • ↔ 350 x 110 - VE/PU: 8
incl. 2 x 9W • GU10 • 700lm • 3000K • A+
A+ 1400lm • 18 kWh/1000h • 230V



89584

Ø 70 x 31 - VE/PU: 10
9W • GU10 • 700lm • 3000K • A+
A+ 700lm • 9 kWh/1000h • 230V

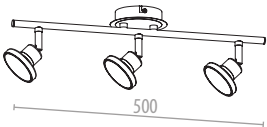

760044-3

↓ 145 • ↔ 500 x 110 - VE/PU: 8
incl. 3 x 9W • GU10 • 700lm • 3000K • A+
A+ 2100lm • 27 kWh/1000h • 230V

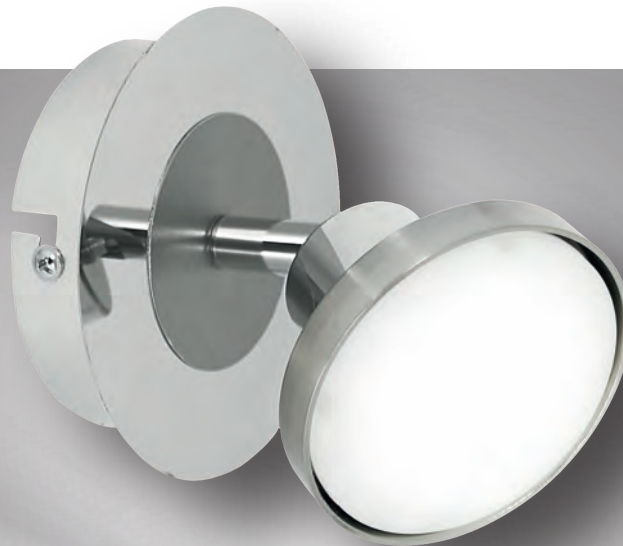

760044-1



760044-4



760044-3



760044-2

Stahl gebürstet • Chrom • Acryl
metal brushed • chrome • acrylic
métal brossé • chrome • acrylique

incl. 3W  G9 LED

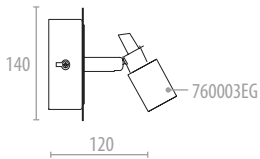

760003-1

120 x 70 x 140 • VE/PU: 12
incl. 1 x 3 W • G9 • 300lm • 3000K • A++

A++ 300lm • 3 kWh/1000h • 230V

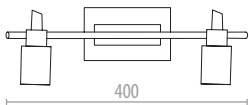

760003-2

400 x 90 x 140 • VE/PU: 12
incl. 2 x 3 W • G9 • 300lm • 3000K • A++

A++ 600lm • 6 kWh/1000h • 230V

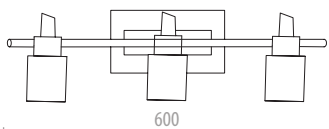

760003-3

600 x 95 x 140 • VE/PU: 6
incl. 3 x 3 W • G9 • 300lm • 3000K • A++

A++ 900lm • 9 kWh/1000h • 230V

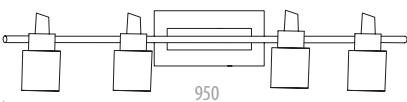

760003-4

950 x 95 x 140 • VE/PU: 6
incl. 4 x 3 W • G9 • 300lm • 3000K • A++

A++ 1200lm • 12 kWh/1000h • 230V



760003-4



tauschbar
↔
changeable

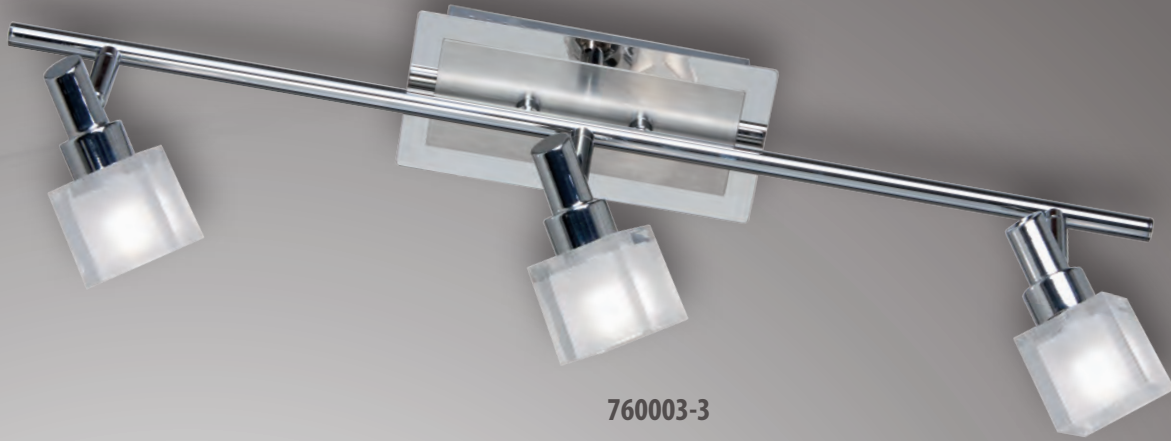

760003-3

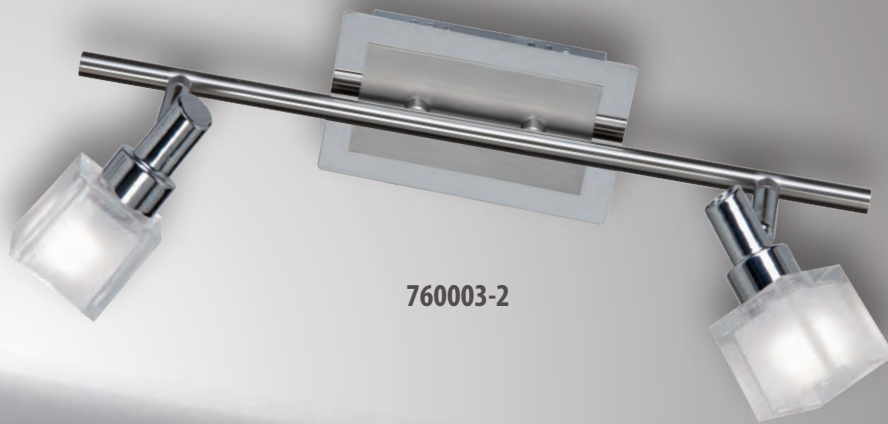

760003-2



760003-1

Holz • Stahl gebürstet
wood • metal brushed
bois • métal brossé

incl. SMD LED

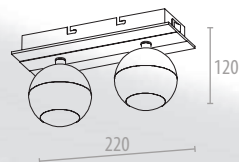

762032-2

220 x 80 x 120 • VE/PU: 8
incl. 2 x 6 W • SMD-LED • 420lm • 3000K • A+

A+ 840lm • 12 kWh/1000h • 230V

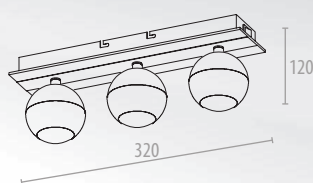

762032-3

320 x 80 x 120 • VE/PU: 8
incl. 3 x 6 W • SMD-LED • 420lm • 3000K • A+

A+ 1260lm • 18 kWh/1000h • 230V

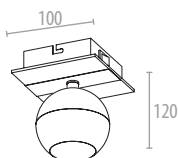

762032-1

100 x 100 x 120 • VE/PU: 16
incl. 1 x 6 W • SMD-LED • 420lm • 3000K • A+

A+ 420lm • 6 kWh/1000h • 230V

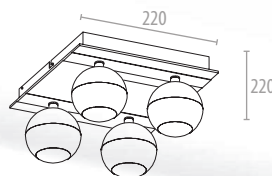

762032-4

220 x 220 x 120 • VE/PU: 4
incl. 4 x 6 W • SMD-LED • 420lm • 3000K • A+

A+ 1680lm • 24 kWh/1000h • 230V



762032-1

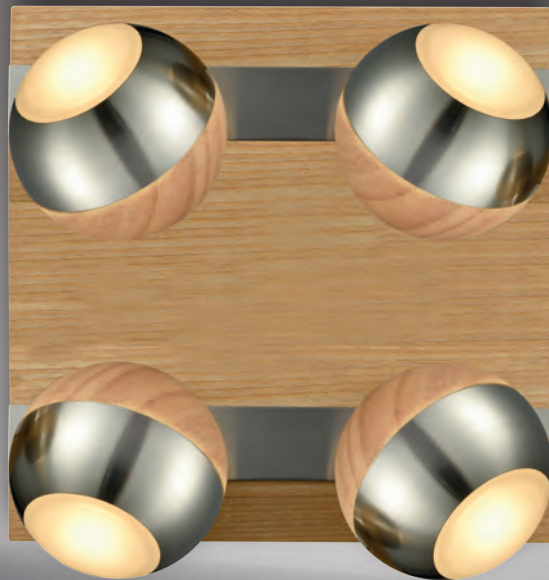

762032-4

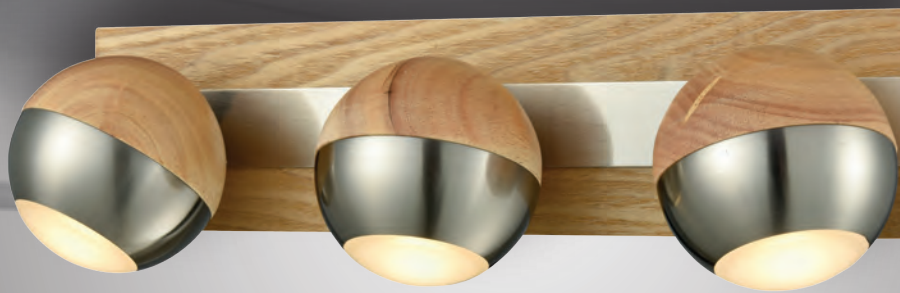

762032-3

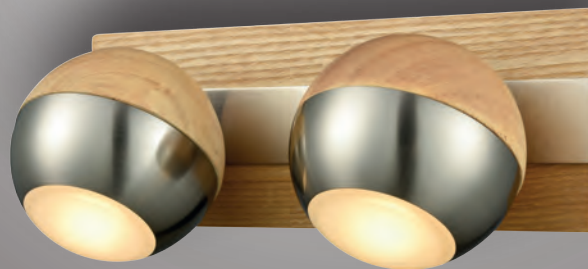

762032-2

Stahl gebürstet • Chrom • Glas
metal brushed • chrome • glass
métal brossé • chrome • verre

incl. 2,5W G9 LED



760004-1

190 x 70 x 160 - VE/PU: 4
incl. 1 x 2,5 W - G9
200lm - 3000K - A+

A+ 200lm

3 kWh/1000h - 230V

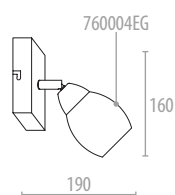

760004-2

300 x 70 x 190 - VE/PU: 4
incl. 2 x 2,5 W - G9
200lm - 3000K - A+

A+ 400lm

5 kWh/1000h - 230V

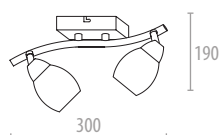

760004-3

Ø 300 x 190 - VE/PU: 4
incl. 3 x 2,5 W - G9
200lm - 3000K - A+

A+ 600lm

8 kWh/1000h - 230V

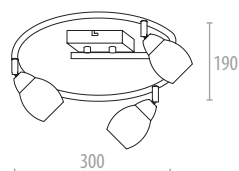

760004-4

600 x 70 x 190 - VE/PU: 4
incl. 4 x 2,5 W - G9
200lm - 3000K - A+

A+ 800lm

10 kWh/1000h - 230V

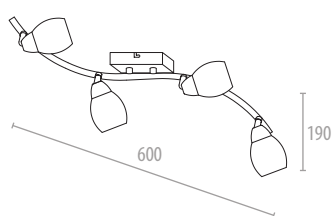

760004-6

1350 x 70 x 190 - VE/PU: 4
incl. 6 x 2,5 W - G9
200lm - 3000K - A+

A+ 1200lm

15 kWh/1000h - 230V

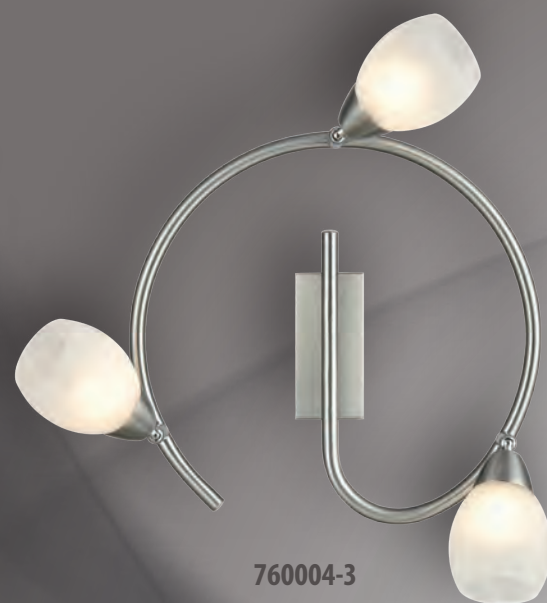
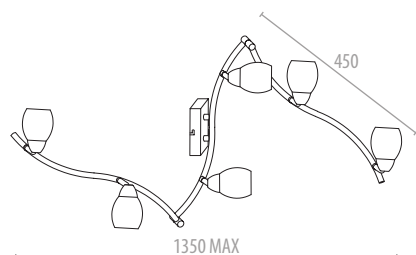

760004-3

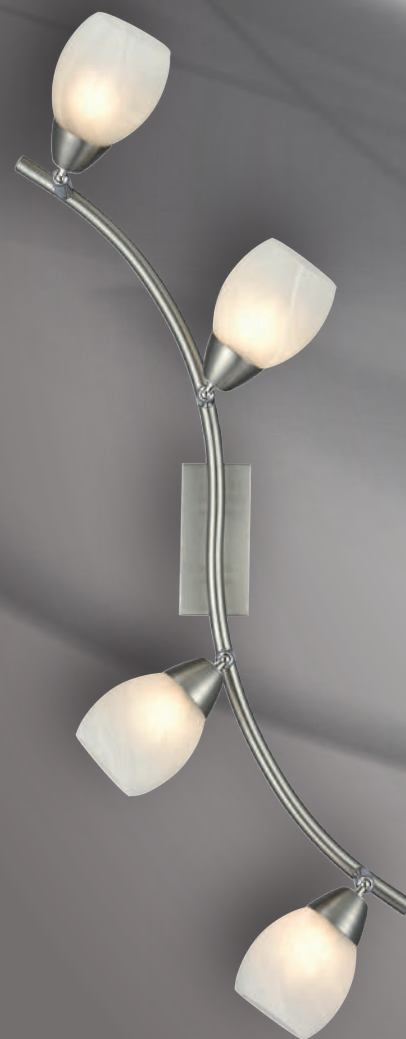

760004-4



tauschbar
↔
changeable



760004-6



760004-2



760004-1

Stahl gebürstet • Chrom • Glas
metal brushed • chrome • glass
métal brossé • chrome • verre

incl. 2,5W  G9 LED



760016-1

85 x 155 x 85 - VE/PU: 4
incl. 1 x 2,5 W - G9 - 200lm - 3000K - A+

A+ → 200lm - 3 kWh/1000h - 230V

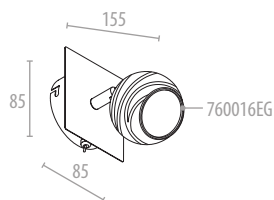

760016-2

300 x 180 x 90 - VE/PU: 4
incl. 2 x 2,5 W - G9 - 200lm - 3000K - A+

A+ → 400lm - 5 kWh/1000h - 230V

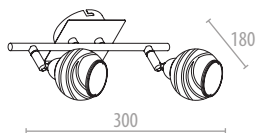

760016-3

450 x 180 x 90 - VE/PU: 4
incl. 3 x 2,5 W - G9 - 200lm - 3000K - A+

A+ → 600lm - 8 kWh/1000h - 230V

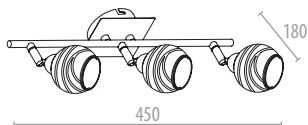

760016-4

600 x 180 x 90 - VE/PU: 4
incl. 4 x 2,5 W - G9 - 200lm - 3000K - A+

A+ → 800lm - 10 kWh/1000h - 230V

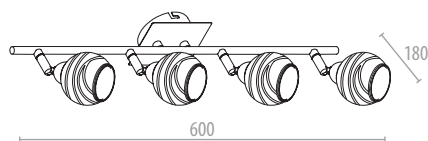

760016-4

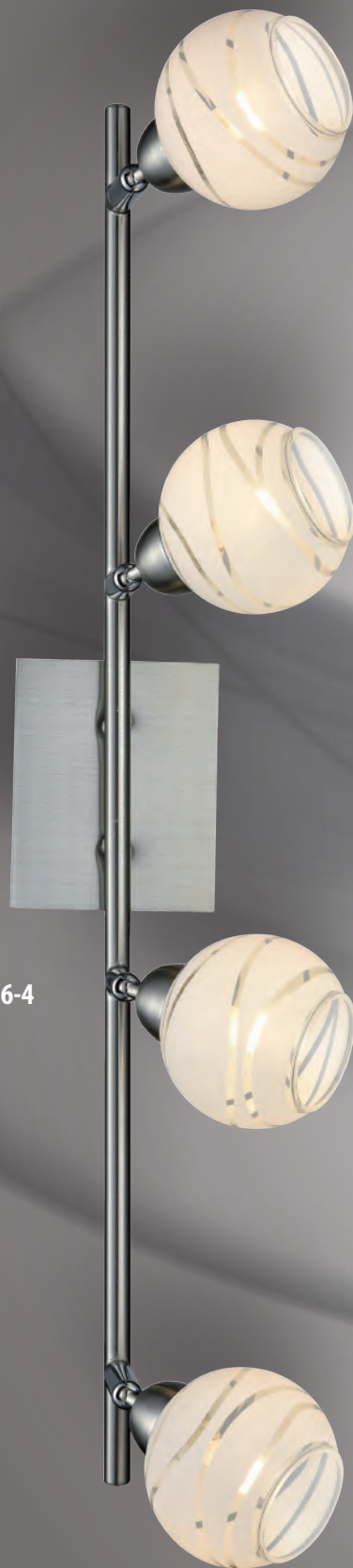



tauschbar
↔
changeable



760016-3



760016-2



760016-1

Chrom • Glas
chrome • glass
chrome • verre

42W  G9 230V

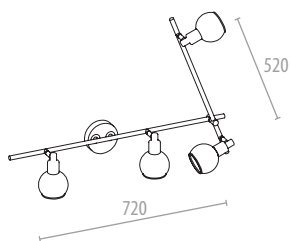

42003-4

720 x 520 max. • VE/PU: 4
4 x 42 W • G9 • 230V

A++ bis E

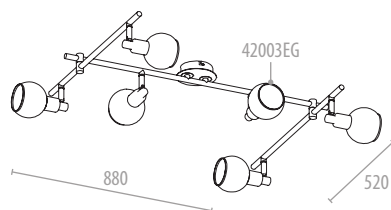

42003-6

880 x 520 max. • VE/PU: 6
6 x 42 W • G9 • 230V

A++ bis E

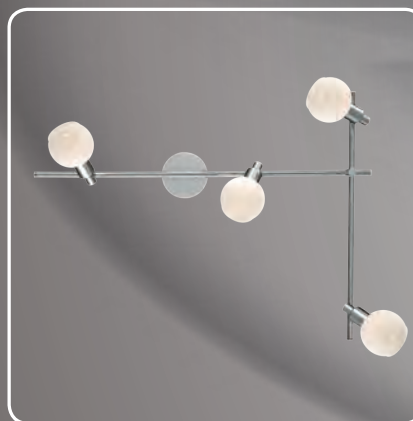

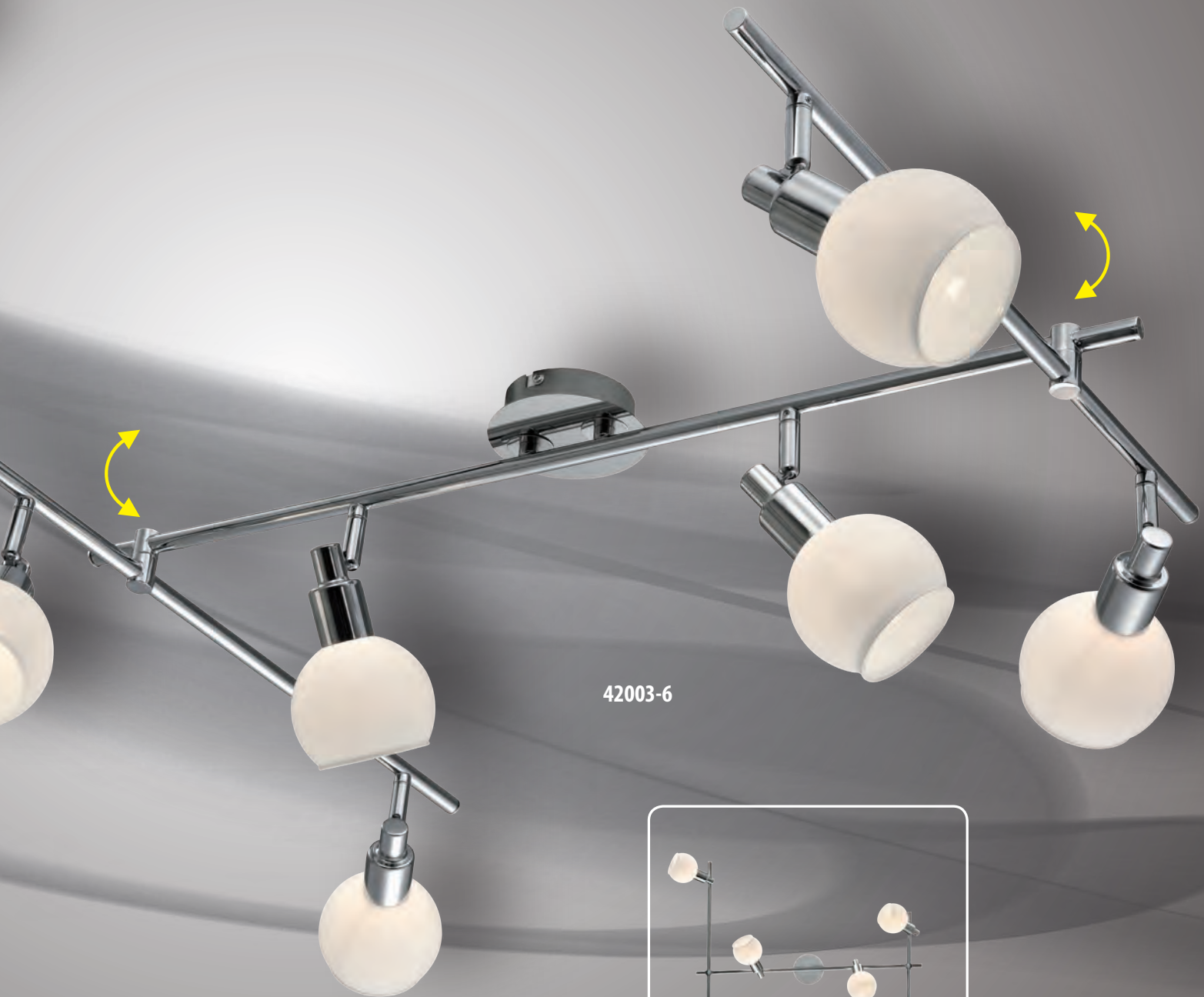

42003-6

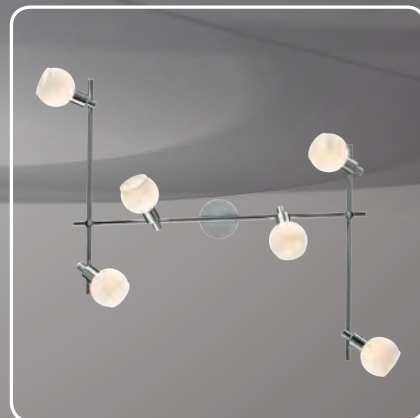

Stahl gebürstet • Chrom • Glas
metal brushed • chrome • glass
métal brossé • chrome • verre

40W  E14 230V

60710-1

↑ 190 - VE/PU: 12
1 x 40 W - E14 - 230V

A++ bis E

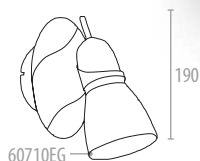

60710EG

60710-2

↔ 400 - VE/PU: 12
2 x 40 W - E14 - 230V

A++ bis E

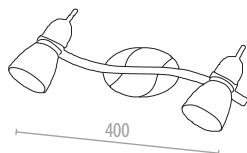

400

60710-3

Ø 470 - VE/PU: 6
3 x 40 W - E14 - 230V

A++ bis E

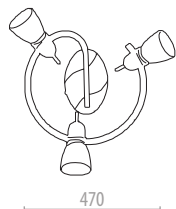

470

60710-4

↔ 980 - VE/PU: 6
4 x 40 W - E14 - 230V

A++ bis E

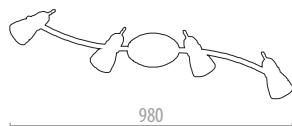

980

60710-6

↔ 1180 - VE/PU: 6
6 x 40 W - E14 - 230V

A++ bis E

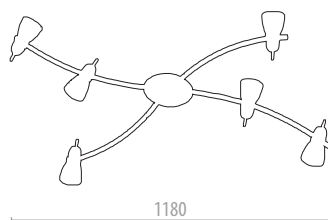

1180

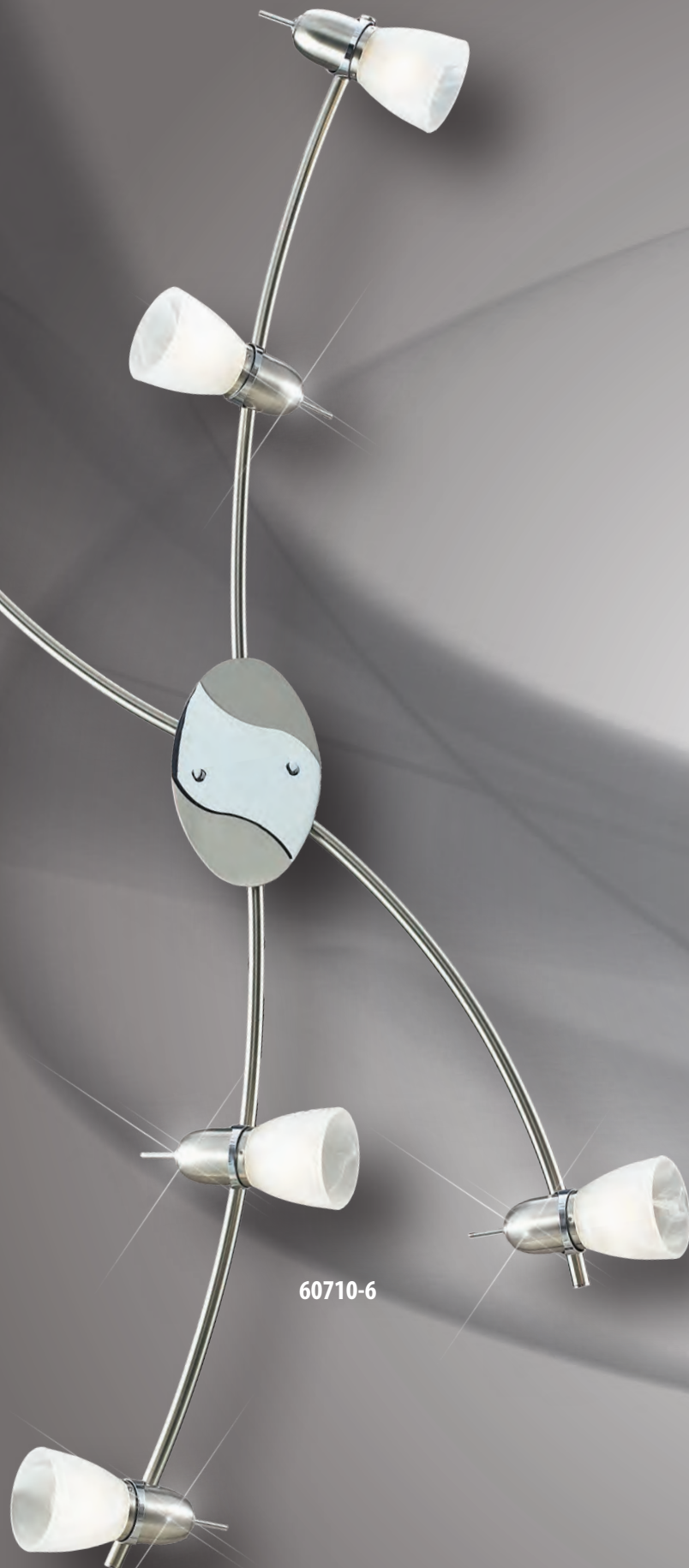

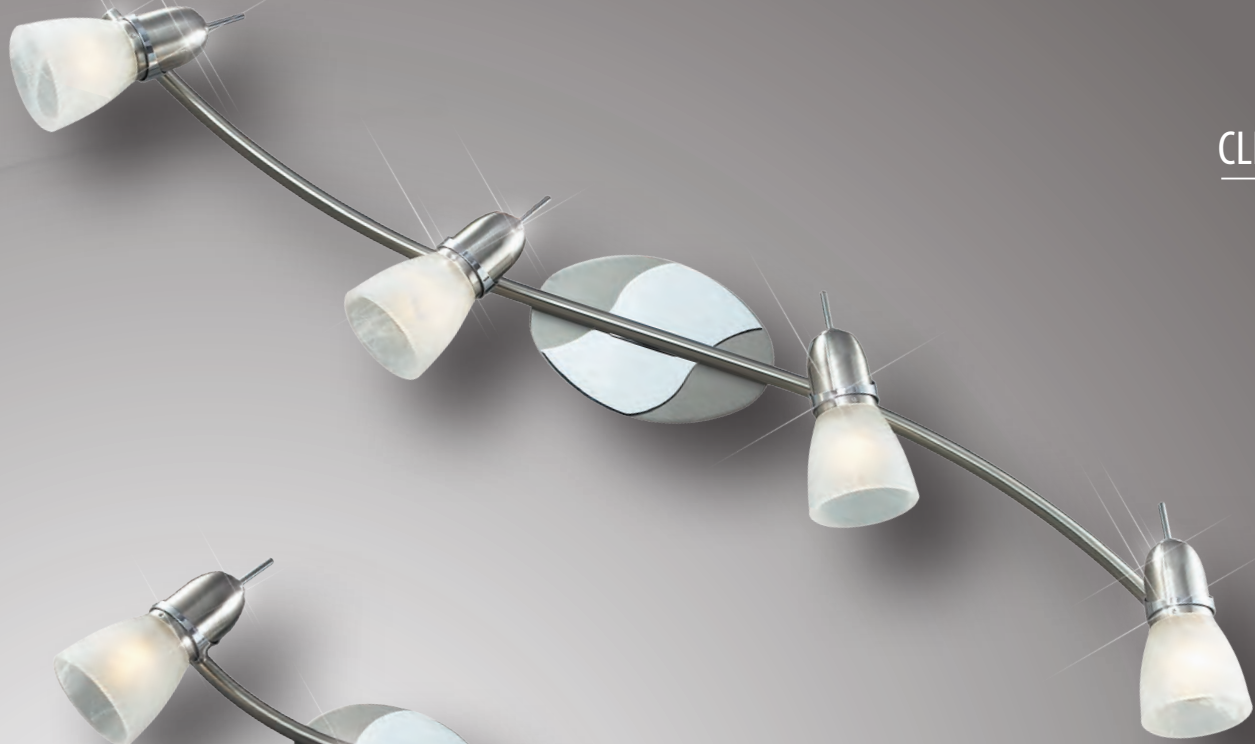

60710-4



60710-2



60710-3



60710-1

Stahl gebürstet • Glas
metal brushed • glass
métal brossé • verre

40W  E14 230V

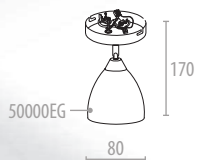

50000-1

∅ 80 x 170 - VE/PU: 20
1 x 40 W • E14 • 230V

A++ bis E

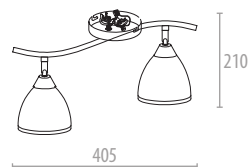

50000-2

↔ 405 x 210 - VE/PU: 10
2 x 40 W • E14 • 230V

A++ bis E

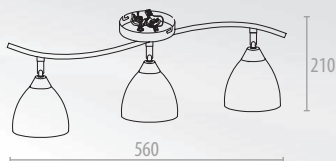

50000-3

↔ 560 x 210 - VE/PU: 10
3 x 40 W • E14 • 230V

A++ bis E

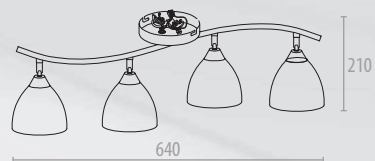

50000-4

↔ 640 x 210 - VE/PU: 10
4 x 40 W • E14 • 230V

A++ bis E



50000-1



50000-4



50000-3



50000-2

Stahl gebürstet • Chrom • Glas
metal brushed • chrome • glass
métal brossé • chrome • verre

incl. 3W LED



760050-3

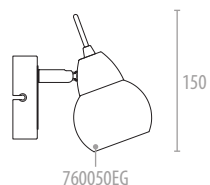

760050-1

Ø 80 • ↑ 150 • VE/PU: 12
incl. 1 x 3 W • G9 • 300lm • 3000K • A++

A++ 300lm • 3 kWh/1000h • 230V

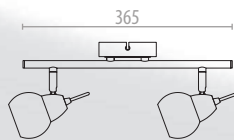

760050-2

365 x 100 x 130 • VE/PU: 8
incl. 2 x 3 W • G9 • 300lm • 3000K • A++

A++ 600lm • 6 kWh/1000h • 230V

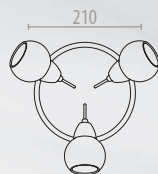

760050-3

Ø 210 • ↓ 150 • VE/PU: 8
incl. 3 x 3 W • G9 • 300lm • 3000K • A++

A++ 900lm • 9 kWh/1000h • 230V

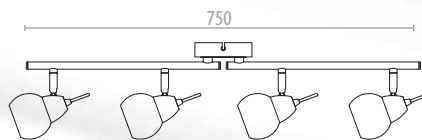

760050-4

750 x 100 x 170 • VE/PU: 6
incl. 4 x 3 W • G9 • 300lm • 3000K • A++

A++ 1200lm • 12 kWh/1000h • 230V

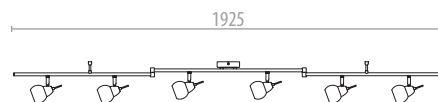

760050-6

1925 x 100 x 185 • VE/PU: 4
incl. 6 x 3 W • G9 • 300lm • 3000K • A++

A++ 1800lm • 18 kWh/1000h • 230V



760050-1



tauschbar
↔
changeable



760050-6

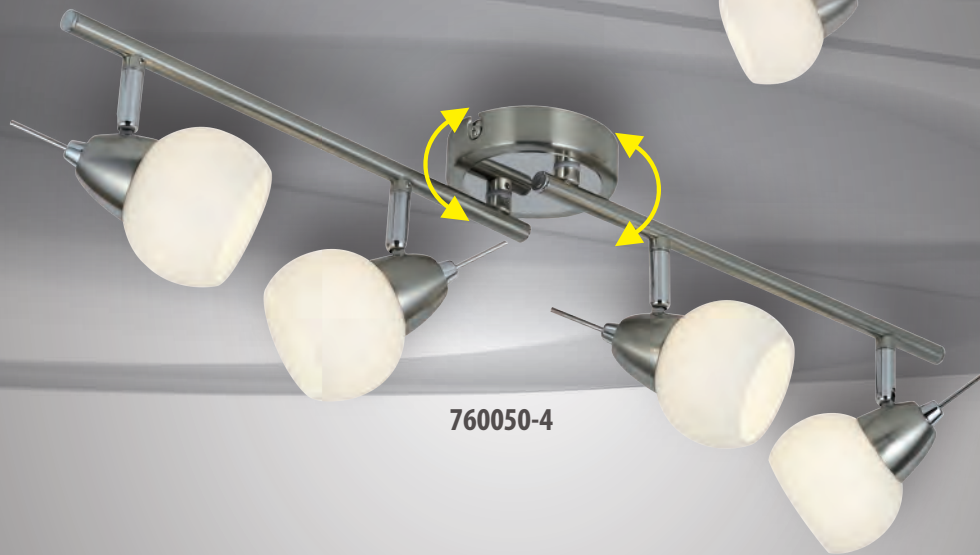

760050-4



760050-2

Stahl gebürstet • Chrom
metal brushed • chrome
métal brossé • chrome

incl. 3W  GU10 SMD-LED 230V

LED tauschbar
changeable  3.000K
warm white

760008-1

Ø 70 x 140 - VE/PU: 20
incl. 1 x 3 W - GU10 - 240lm - 3000K - A+
A+ 240lm - 3 kWh/1000h - 230V



9 003348 158083

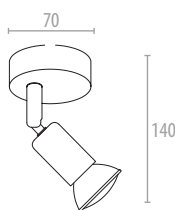

760008-2

↔ 300 x 150 - VE/PU: 10
incl. 2 x 3 W - GU10 - 240lm - 3000K - A+
A+ 480lm - 6 kWh/1000h - 230V



9 003348 158090

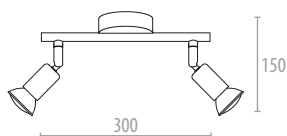

760008-3

Ø 255 - VE/PU: 10
incl. 3 x 3 W - GU10 - 240lm - 3000K - A+
A+ 720lm - 9 kWh/1000h - 230V



9 003348 158106

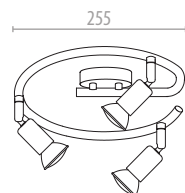

760008-4

↔ 850 - VE/PU: 10
incl. 4 x 3 W - GU10 - 240lm - 3000K - A+
A+ 960lm - 12 kWh/1000h - 230V



9 003348 158113

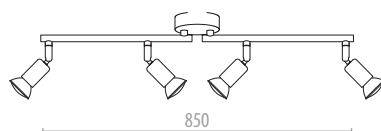

760008-6

↔ 1800 - VE/PU: 10
incl. 6 x 3 W - GU10 - 240lm - 3000K - A+
A+ 1440lm - 18 kWh/1000h - 230V



9 003348 158120

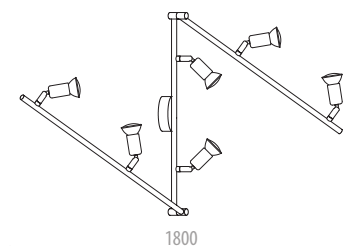

760008-3



760008-1



Chrom • Kunststoff
chrome • plastic
chrome • plastique

incl. SMD LED

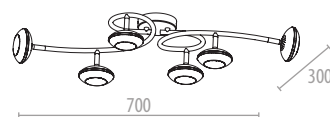

9760013-6

700 x 300, ↑ 120 - VE/PU: 4
incl. 6 x 5 W • SMD-LED • 340lm • 3000K • A+

A+ 2040lm • 30 kWh/1000h • 230V



9760012-3

↔ 480, ↑ 140 - VE/PU: 10
incl. 3 x 5 W • SMD-LED • 340lm • 3000K • A+

A+ 1020lm • 15 kWh/1000h • 230V

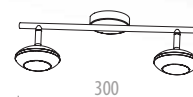

9760012-2

↔ 300, ↑ 140 - VE/PU: 10
incl. 2 x 5 W • SMD-LED • 340lm • 3000K • A+

A+ 680lm • 10 kWh/1000h • 230V

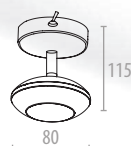

9760012-1

Ø 80 - VE/PU: 50
incl. 1 x 5 W • SMD-LED • 340lm • 3000K • A+

A+ 340lm • 5 kWh/1000h • 230V



9760012-1



9760013-6



9760012-3



9760012-2

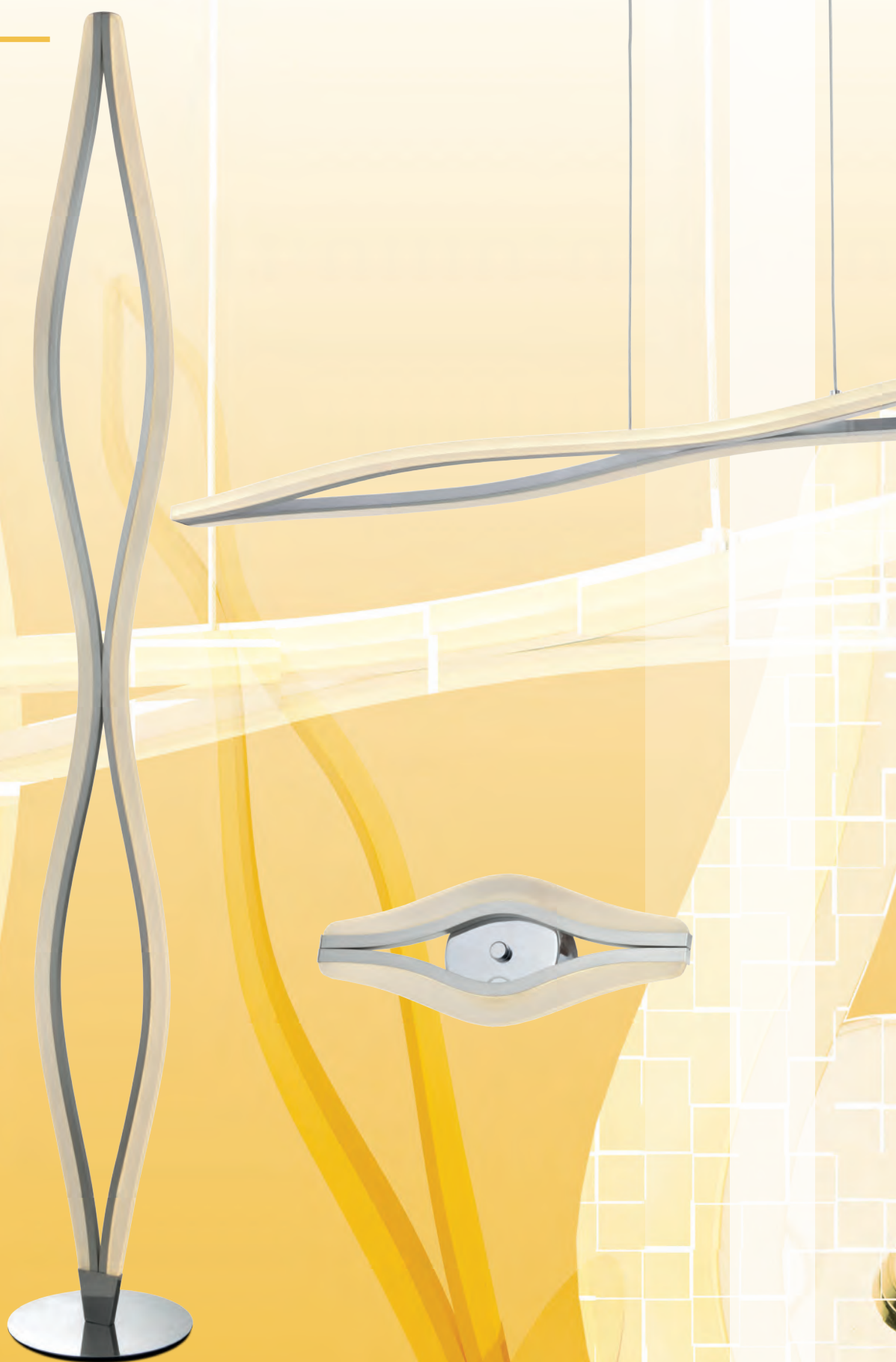

05

Leuchtenfamilien

lamp series

série de lamp

DECENT	03
NOREEN	05
SILUR	07
AMIRA	09
DELILA	11
COMBO	13
WAVE LINE	17
ARION	19
LINE	21
SWORD LED	23
KOLEOS	25
SWORD LED	29
DREAM	31
MODUS	33
KOLEOS	37

43020

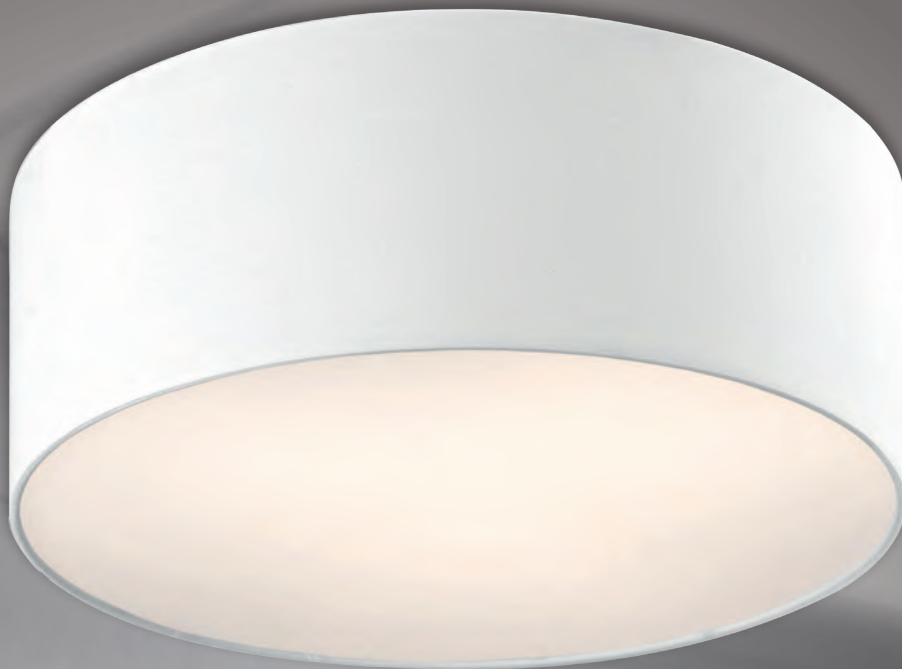

43022



43023



43024



43025

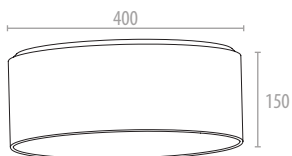

43020 
Ø 400 x 150 - VE/PU: 2
3 x 60 W - E27 - 230V

A++ bis E



43022 
Ø 400 x 150 - VE/PU: 2
3 x 60 W - E27 - 230V

A++ bis E



43023 
Ø 400 x 150 - VE/PU: 2
3 x 60 W - E27 - 230V

A++ bis E



43024 
Ø 400 x 150 - VE/PU: 2
3 x 60 W - E27 - 230V

A++ bis E



43025 
Ø 400 x 150 - VE/PU: 2
3 x 60 W - E27 - 230V

A++ bis E



Chintz • Kunststoff • Metall
Chintz • plastic • metal
Chintz • plastique • métal



710002

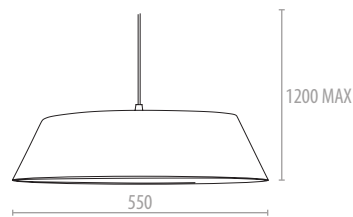
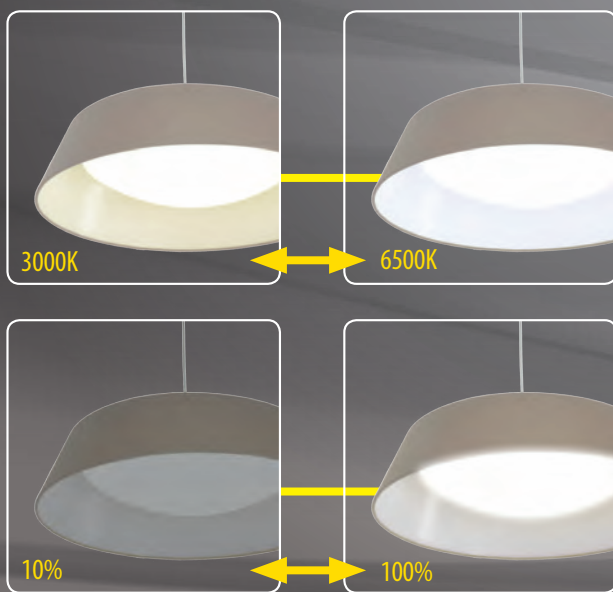

710002

Ø 550 • ↓ 1200 • VE/PU: 2
incl. 1 x 24 W • SMD-LED • 1920lm • 2700 - 6000K • A+

A+ 1920lm • 24 kWh/1000h • 230V



Metall weiß • Chintz
metal white • Chintz
métal blanc • Chintz

incl. SMD LED

Aluminium • Chrom • Acryl
aluminium • chrome • acrylic
aluminium • chrome • acrylique

incl. SMD LED

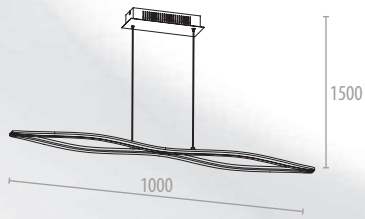

780250

↔ 1000 x 125 • ↑ 1500 • VE/PU: 4
incl. 1 x 21,6 W • SMD LED • 1512lm • 3000K • A+

A+ 1512lm • 22 kWh/1000h • 230V



9 003348 142822



780253

300 x 118 x 50 • VE/PU: 12
incl. 1 x 6,5 W • SMD LED • 455lm • 3000K • A+

A+ 455lm • 7 kWh/1000h • 230V



9 003348 142853

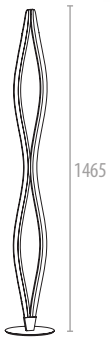

780256

↑ 1465 • Ø 220 • VE/PU: 4
incl. 1 x 30,8 W • SMD LED • 2156lm • 3000K • A+

A+ 2156lm • 31 kWh/1000h • 230V



9 003348 142884



780256





780250



780253

Aluminium • Chrom • Acryl
aluminium • chrome • acrylic
aluminium • chrome • acrylique

incl. SMD LED

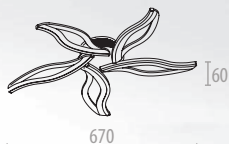

780221-5

Ø 670 • ↓ 60 • VE/PU: 4
incl. 5 x 5,4 W • SMD-LED • 378lm • 3000K • A+

A+ 1890lm • 27 kWh/1000h • 230V



9 1003348 1154948



780224

↑ 1310 • Ø 180 • VE/PU: 4
incl. 1 x 21 W • SMD-LED • 1470lm • 3000K • A+

A 1470lm • 21 kWh/1000h • 230V



9 1003348 1156409



780224



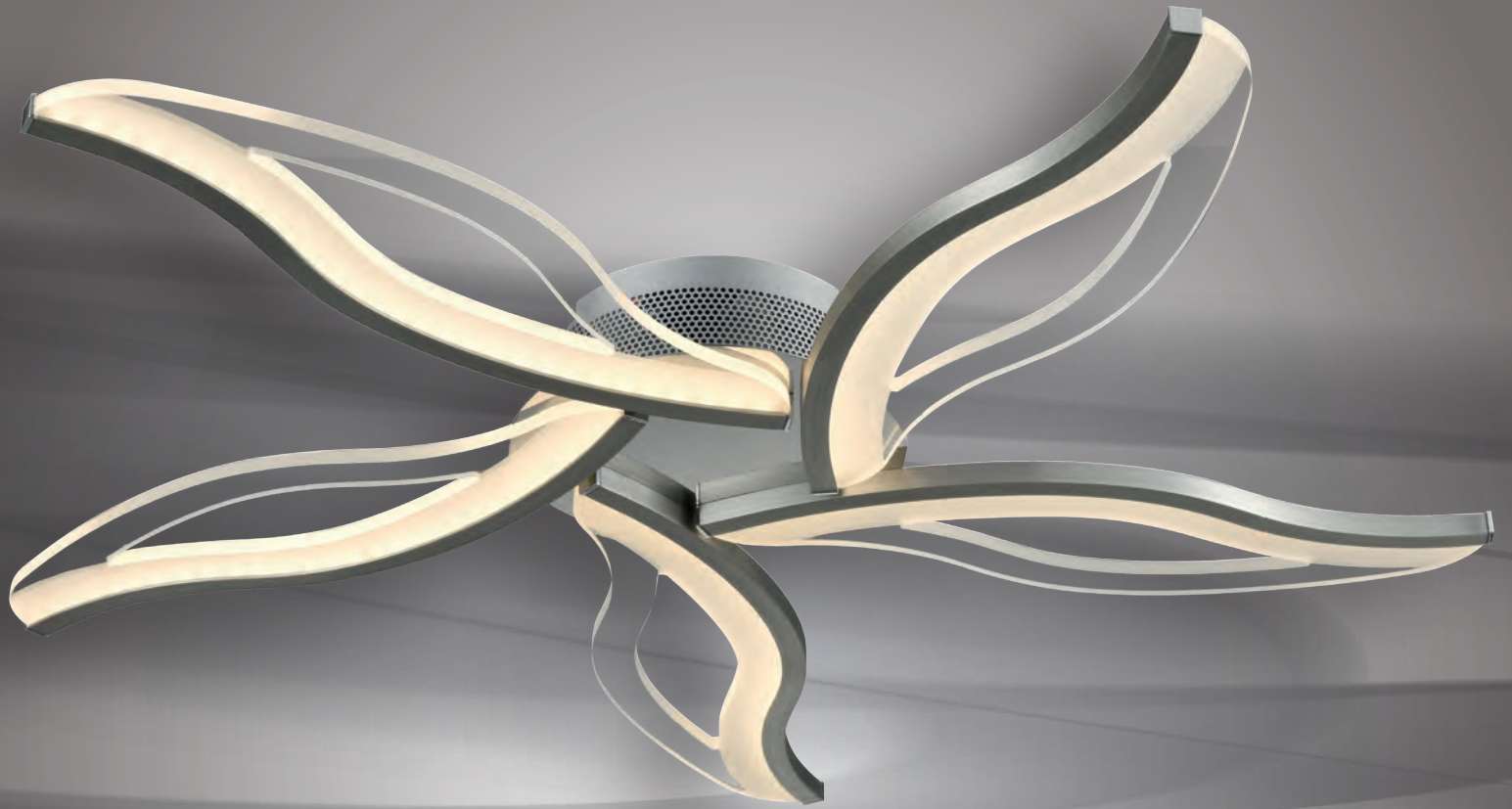

780221-5

Stahl gebürstet • Chrom • Acryl
metal brushed • chrome • acrylic
métal brossé • chrome • acrylique

incl. SMD LED

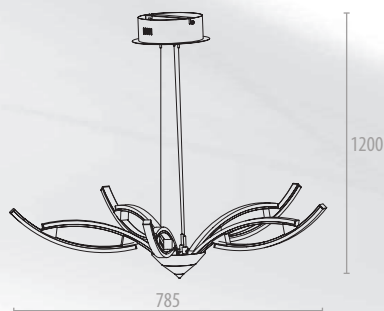

780055-5

Ø 785 • ↓ 1200 • VE/PU: 2
incl. 5 x 6 W • SMD-LED • 480lm • 3000K • A+
incl. 1 x 2 W • SMD-LED • 160lm • 3000K • A+
A+ 2560lm • 32 kWh/1000h • 230V



9 003348 157154

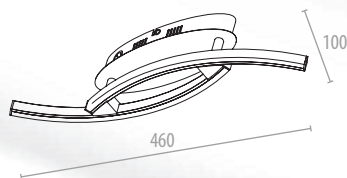

780057

460 x 80 x 100 • VE/PU: 4
incl. 2 x 4 W • SMD-LED • 320lm • 3000K • A+
A+ 640lm • 8 kWh/1000h • 230V



9 003348 157178



780057



5 x 6W • 480lm
3000K

1 x 2W • 160lm
3000K

780055-5

Stahl gebürstet • Acryl
metal brushed • acrylic
métal brossé • acrylique

incl. SMD LED

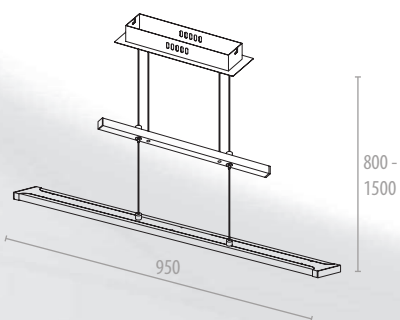

780226-2

↔ 950 x 90 • ↓ 800-1500 • VE/PU: 4
incl. 2 x 15 W • SMD-LED • 1200lm • 3000K • A+

A+ 2400lm • 30 kWh/1000h • 230V

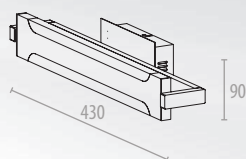

780227-2

430 x 90 x 95 • VE/PU: 6
incl. 2 x 5 W • SMD-LED • 400lm • 3000K • A+

A+ 800lm • 10 kWh/1000h • 230V



780229-2

↑ 430, 150 x 80 • VE/PU: 8
incl. 2 x 5 W • SMD-LED • 400lm • 3000K • A+

A+ 800lm • 10 kWh/1000h • 230V



780229-2



„PRINCE“ Spotleuchten • spotlights • spots



4.21

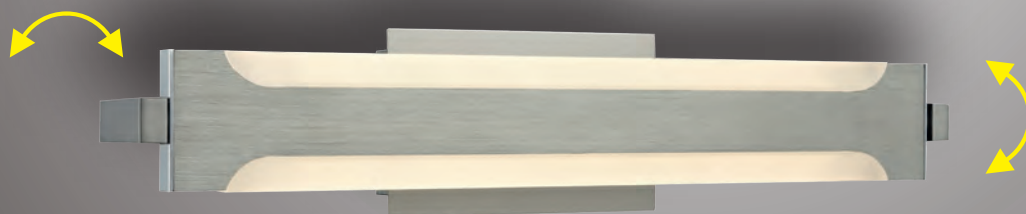
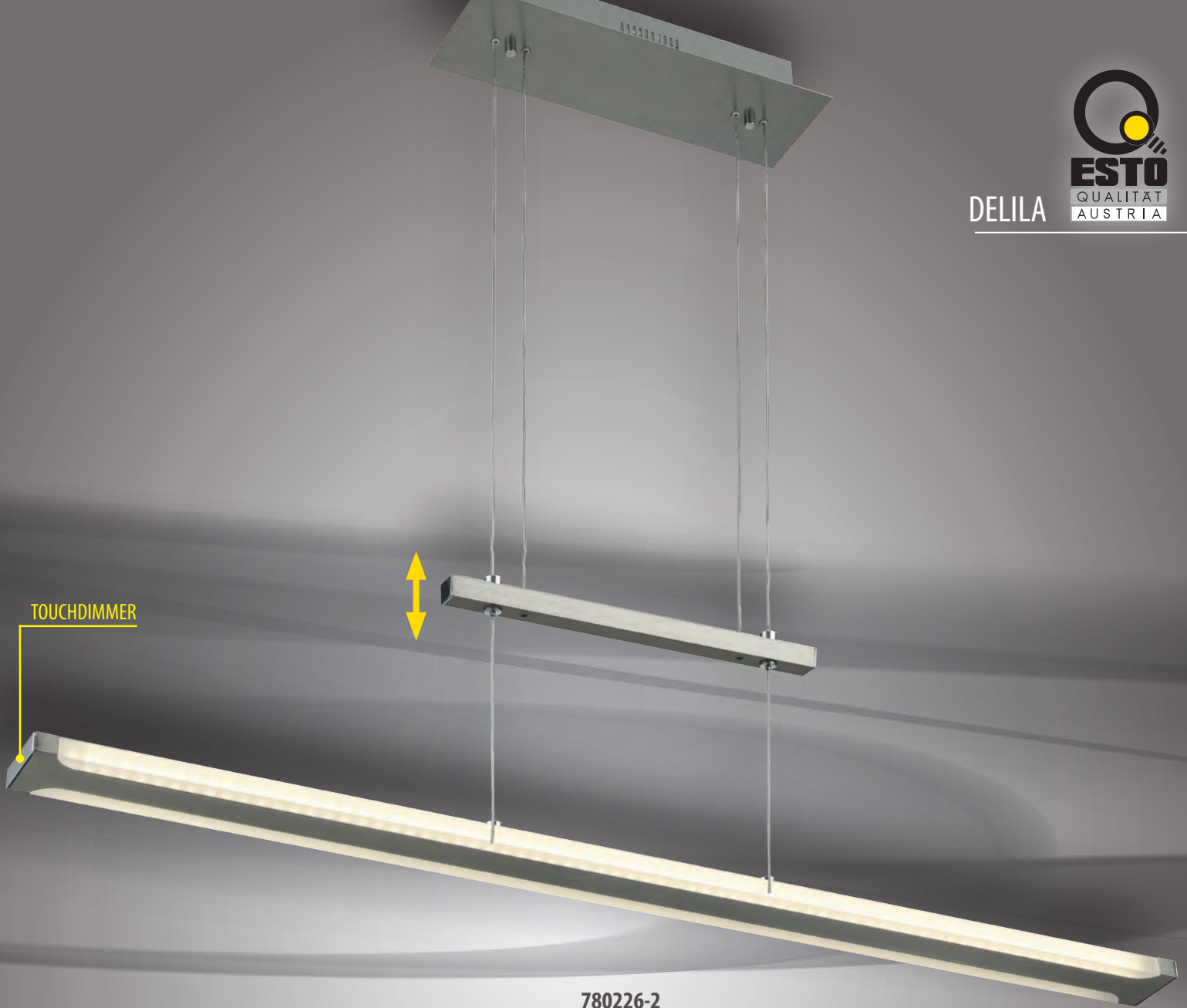

780227-2

Stahl gebürstet • Chrom • Acryl
metal brushed • chrome • acrylic
métal brossé • chrome • acrylique

incl. SMD LED

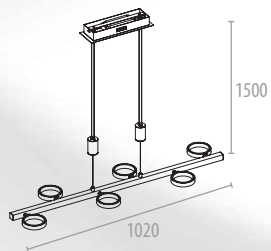

762062-6

1020 x 280 • ↓ 1500 • VE/PU: 4
incl. 6 x 4,8 W • SMD-LED • 360lm • 3000K • A
incl. 1 x 6 W • SMD-LED • 480lm • 3000K • A

A → 2640lm • 35 kWh/1000h • 230V



TOUCH

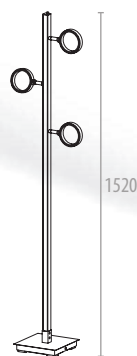

762064-3

200 x 200 • ↑ 1520 • VE/PU: 2
incl. 3 x 4,8 W • SMD-LED • 380lm • 3000K • A+
incl. 1 x 15 W • SMD-LED • 1260lm • 3000K

A+ → 2400lm • 30 kWh/1000h • DC 24V



TOUCH

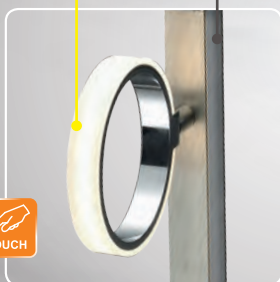
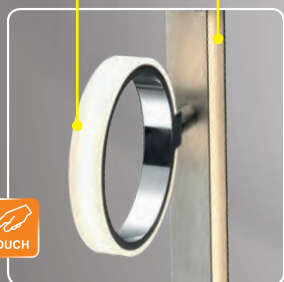

OFF

OFF



762064-3



762062-6



DIMMER



REMOTE
CONTROL

Stahl gebürstet • Chrom • Acryl
metal brushed • chrome • acrylic
métal brossé • chrome • acrylique

incl. SMD LED



762060-1

250 x 80 x 195 - VE/PU: 12
incl. 1 x 4,5 W - SMD-LED - 360lm - 3000K - A+
incl. 1 x 1 W - SMD-LED - 80lm - 3000K - A+

A+ 440lm - 6 kWh/1000h - 230V



9 003348 157079

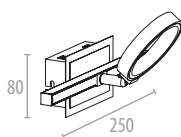

762060-2

380 x 90 x 200 - VE/PU: 8
incl. 2 x 4,5 W - SMD-LED - 360lm - 3000K - A+
incl. 1 x 2,5 W - SMD-LED - 200lm - 3000K - A+

A+ 920lm - 14 kWh/1000h - 230V



9 003348 157086

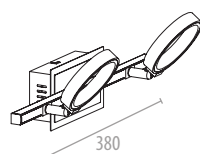

762060-3

615 x 90 x 200 - VE/PU: 8
incl. 3 x 4,5 W - SMD-LED - 360lm - 3000K - A+
incl. 1 x 5 W - SMD-LED - 400lm - 3000K - A+

A+ 1480lm - 19 kWh/1000h - 230V



9 003348 157628

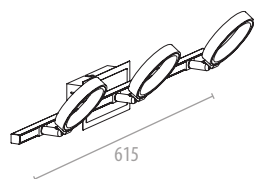

762060-4

870 x 100 x 210 - VE/PU: 4
incl. 4 x 4,5 W - SMD-LED - 360lm - 3000K - A+
incl. 2 x 2,5 W - SMD-LED - 200lm - 3000K - A+

A+ 1840lm - 23 kWh/1000h - 230V



9 003348 157093

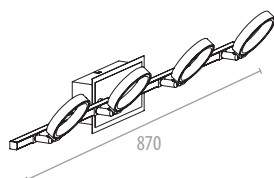

762060-4



762060-3



762060-2

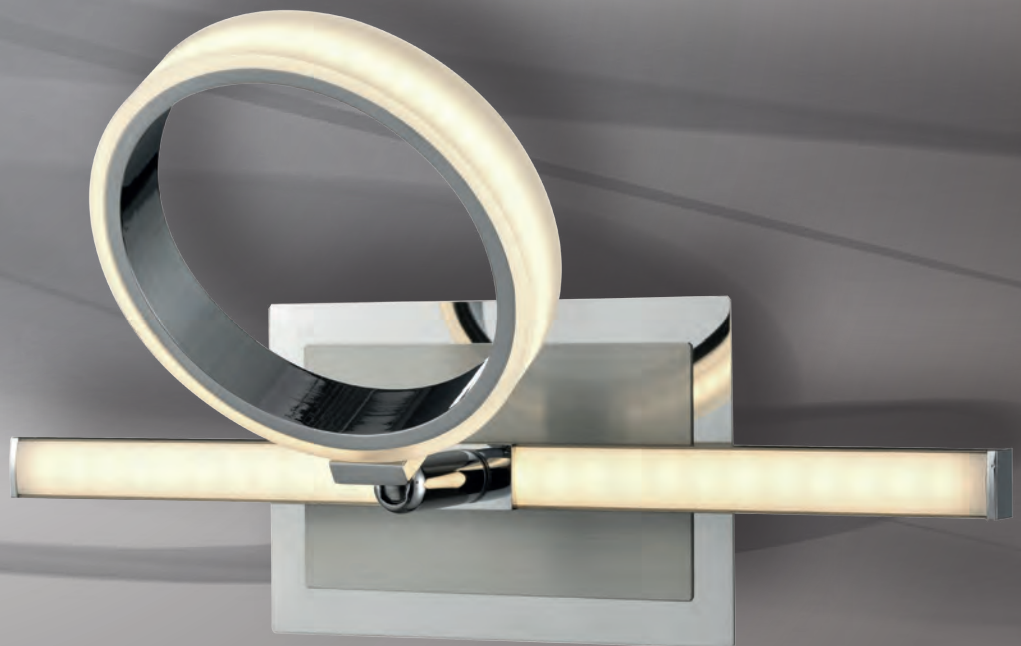

762060-1



780196-2



780195-2

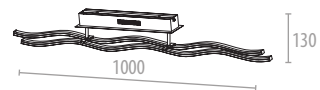
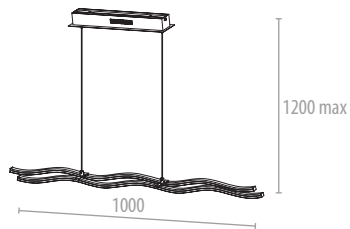

Aluminium • Kunststoff
aluminium • plastic
aluminium • plastique

incl. SMD LED

780195-2

1000 x 80 • ↓ 1200mm • VE/PU: 6
incl. 2 x 10 W • SMD-LED • 800lm • 3500K • A+

A⁺ 1600lm • 20 kWh/1000h • 230V



9 003348 121872

780196-2

1000 x 80 • ↓ 130mm • VE/PU: 6
incl. 2 x 10 W • SMD-LED • 800lm • 3500K • A+

A⁺ 1600lm • 20 kWh/1000h • 230V



9 003348 121896



780194-2

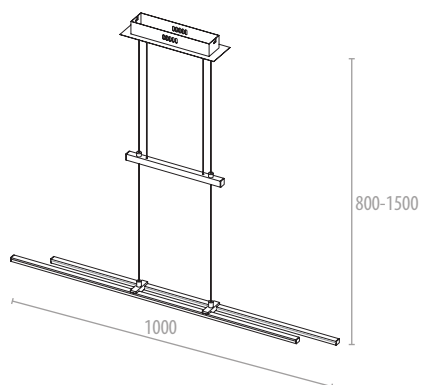
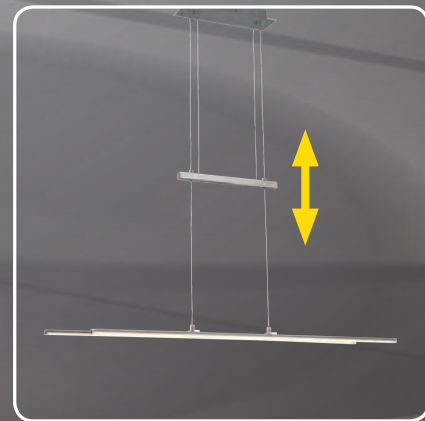
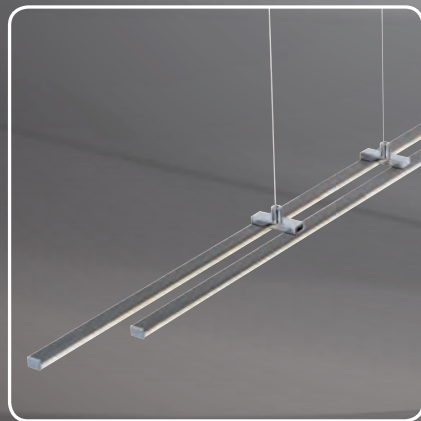

780194-2
 ↔ 1000 x 80, ↓ 800 - 1500 • VE/PU: 6
 incl. 2 x 10 W • SMD-LED • 800lm • 3000K • A+
A+ 1600lm • 20 kWh/1000h • 230V



9 003348 112649 5



Stahl gebürstet • Aluminium • Kunststoff
 metal brushed • aluminium • plastic
 métal brossé • aluminium • plastique

incl. SMD LED

Aluminium gebürstet • Acryl • Metall
aluminium brushed • acrylic • metal
aluminium brossé • acrylique • métal

incl. SMD LED



780202
250 x 130 • ↑ 1200
VE/PU: 2
incl. 2 x 14 W • SMD-LED
1120lm • 3200K • A+
A+ 2240lm
28 kWh/1000h • 230V

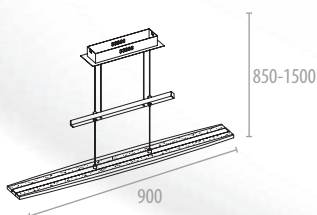

780200
900 x 120 • ↓ 850-1500
VE/PU: 4
incl. 2 x 15 W • SMD-LED
1200lm • 3200K • A+
A+ 2400lm
30 kWh/1000h • 230V

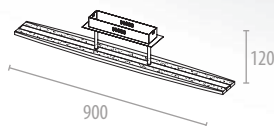

780201
900 x 120 • ↓ 120
VE/PU: 4
incl. 2 x 15 W • SMD-LED
1200lm • 3200K • A+
A+ 2400lm
30 kWh/1000h • 230V

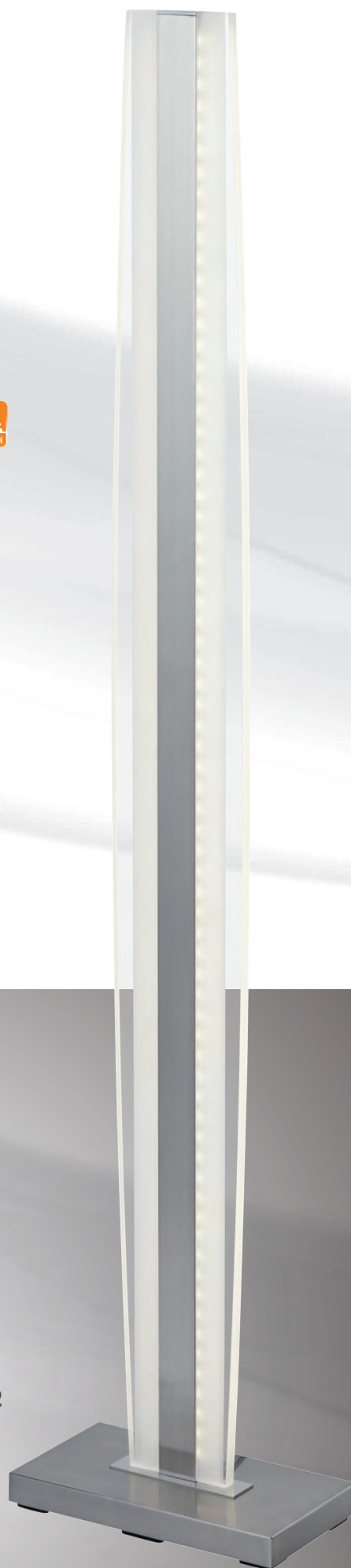

780202

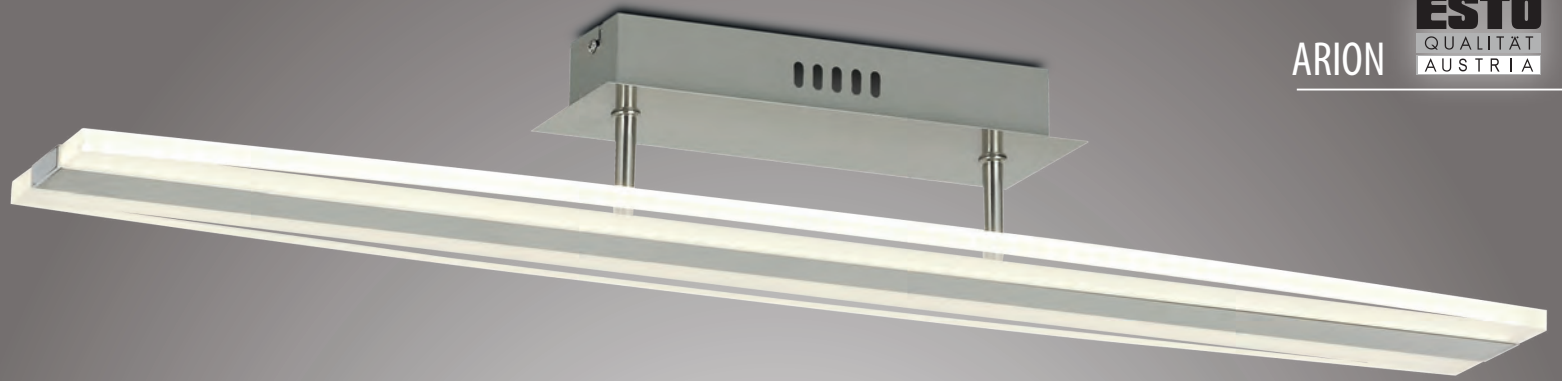

780201

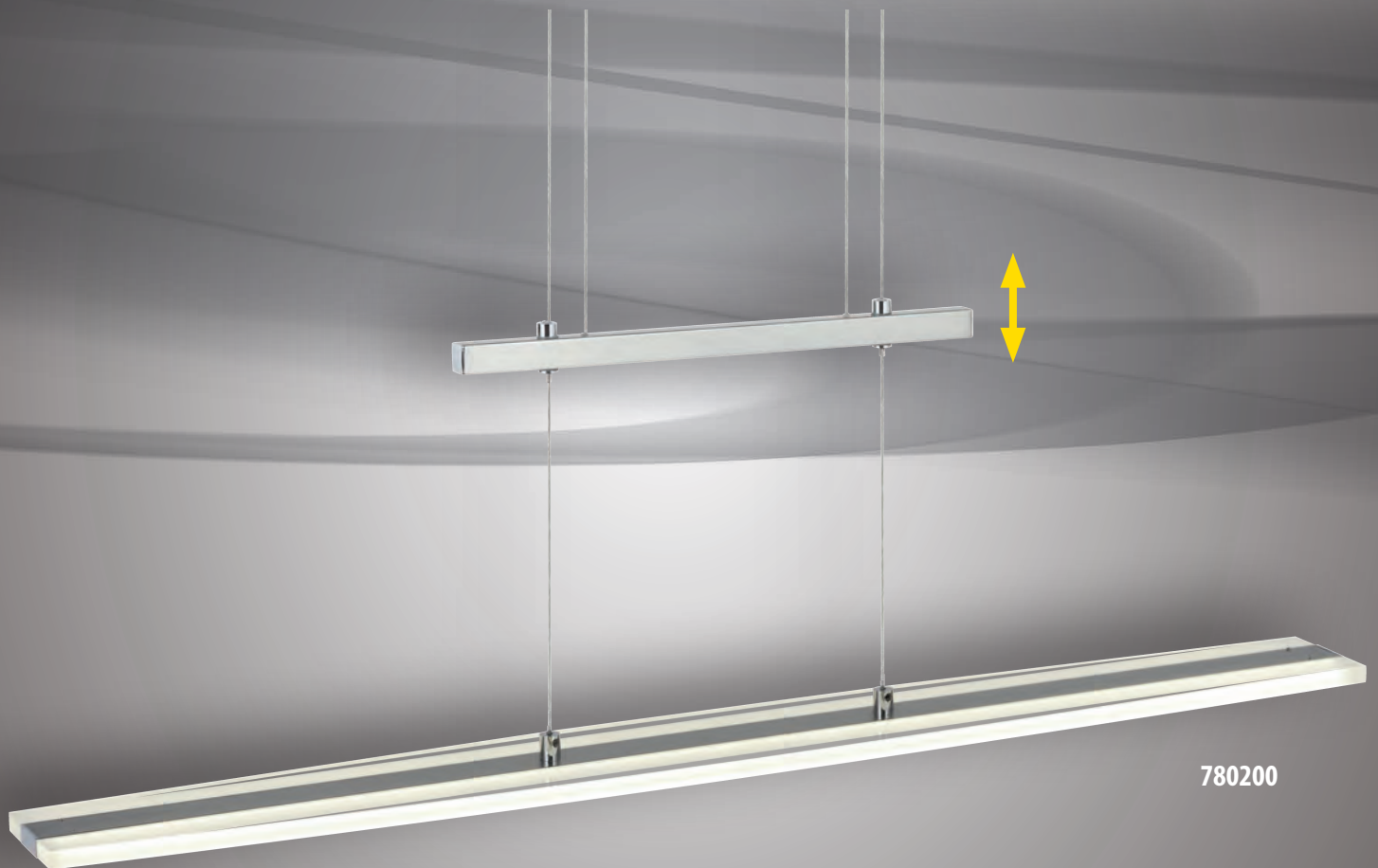

780200

Chrom • Acryl
chrome • acrylic
chrome • acrylique

incl. SMD LED



780152A
250 x 130 - ↑ 1200 - VE/PU: 2
incl. 2 x 14 W - SMD-LED
1120lm - 3200K - A+
A+ 2240lm
28 kWh/1000h - 230V

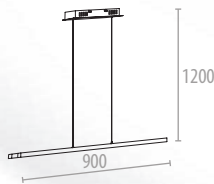

780150A
900 x 100 - ↓ 1200 - VE/PU: 4
incl. 2 x 15 W - SMD-LED
1200lm - 3200K - A+
A+ 2400lm
30 kWh/1000h - 230V

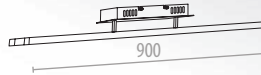

780151A
900 x 100 - ↓ 120 - VE/PU: 4
incl. 2 x 15 W - SMD-LED
1200lm - 3200K - A+
A+ 2400lm
30 kWh/1000h - 230V

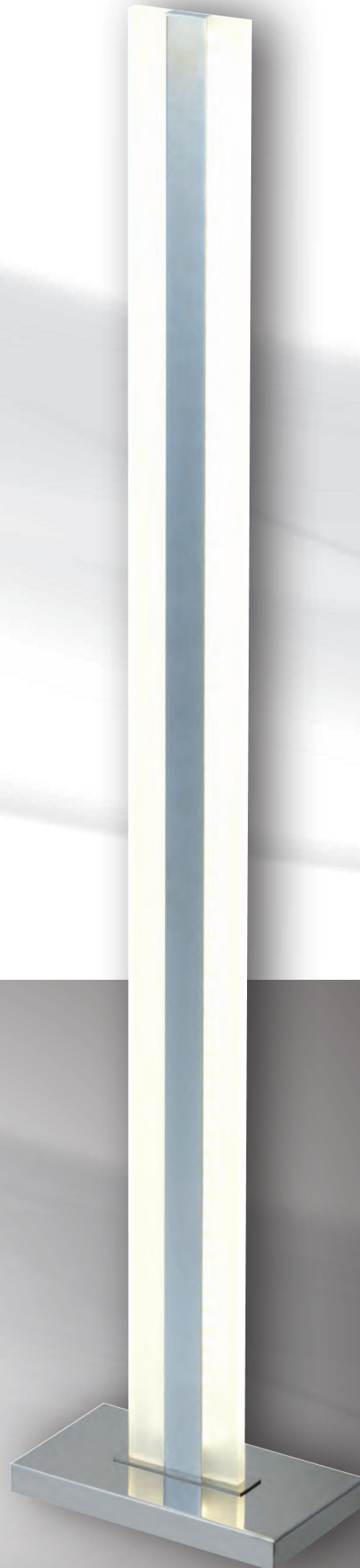

780152A

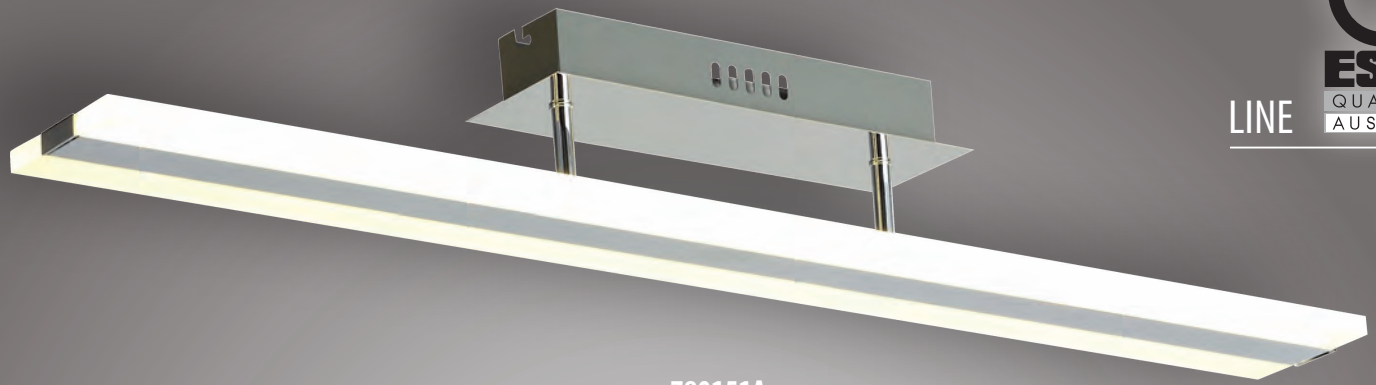

780151A



780150A

Chrom • Acryl
chrome • acrylic
chrome • acrylique

incl. SMD LED

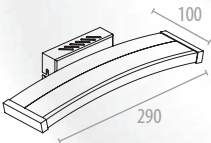

780088

↔ 290 • ↑ 60 x 100 • VE/PU: 4
incl. 1 x 4,8 W • SMD-LED • 310lm • 3000K • A+

A+ 310lm • 5 kWh/1000h • 230V



780087

↑ 1400 x 80 • ↔ 290 • VE/PU: 1
incl. 1 x 36,4 W • SMD-LED • 2370lm • 3000K • A+

A+ 2370lm • 37 kWh/1000h • 230V

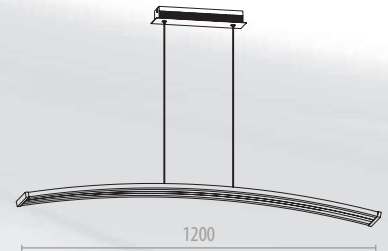

780086

↔ 1200 x 130 • ↓ 1000 • VE/PU: 1
incl. 1 x 35,2 W • SMD-LED • 2290lm • 3000K • A+

A+ 2290lm • 36 kWh/1000h • 230V



780088



780087



Stahl gebürstet • Chrom • Glas
metal brushed • chrome • glass
métal brossé • chrome • verre

incl. 3W  G9 LED



742002-6

900 x 300 x 200 • VE/PU: 3
incl. 6 x 3 W • G9 • 300lm • 3000K • A++

A++ 1800lm • 18 kWh/1000h • 230V



9 003348 108552

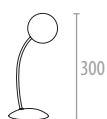

742003-1

↑ 300 • VE/PU: 6
incl. 1 x 3 W • G9 • 300lm • 3000K • A++

A++ 300lm • 3 kWh/1000h • 230V



9 003348 120943



742003-5

↑ 1750 • VE/PU: 3
incl. 5 x 3 W • G9 • 300lm • 3000K • A++

A++ 1500lm • 15 kWh/1000h • 230V



9 003348 120950



742003-5



tauschbar
← →
changeable



742002-6



742003-1



06

Tisch- & Stehleuchten

table- & floorlamps

lampes à poser et lampadaires

AMIDA	03	STUDIO	23
SAYO	04	ALICE	26
CUBE	05	CANDY	26
JIRO	06	LIZ	27
SOUND	07	WENDY	27
KEIKO	08	WANDA	28
RIKU	09	ERICA	31
KOKO	10	FIORINA	32
KOKO	10	LANTERN	33
BELLO	10	JOY	34
YUI	11	SINUS	35
KEIKO	12	PRISTINE	35
FLEXY	16	CURVE	36
DIGGER	17	BELLA LED	37
CLOCK	18	CRYSTAL PIPE	38
MIO	19	VEGAS	39
YUNA	20	DOMINIC	40
YOKO	21	MARIUS	40
MIKA	22		

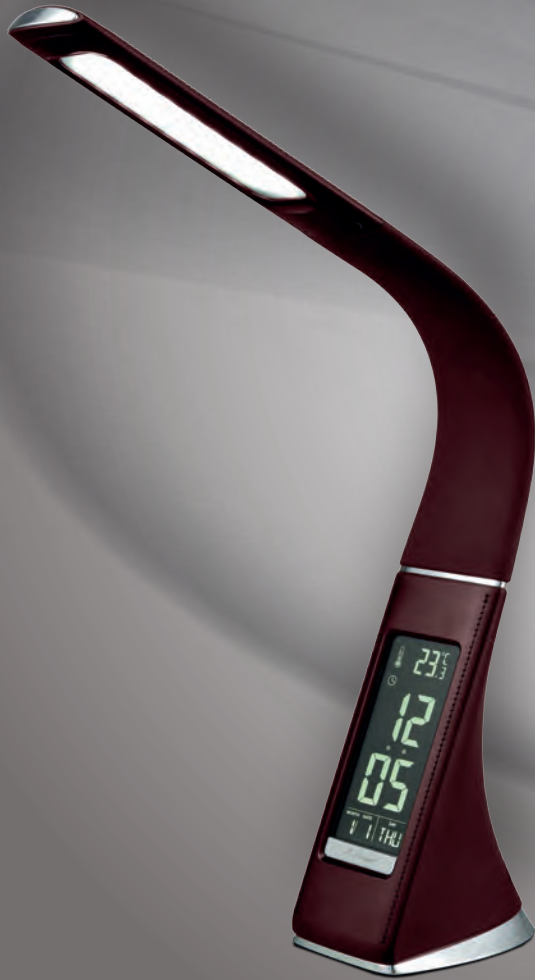

722050



722051

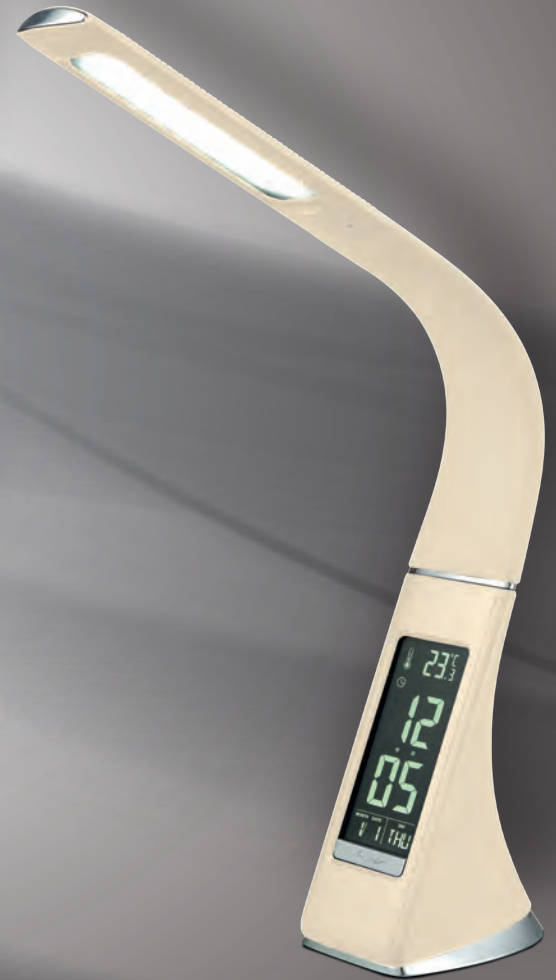

722052

LED	200 Lumen	4.000K white	3 STEPS	TOUCH ON-OFF	TOUCH DIMMER
	°C °F	CALENDAR 31	ALARM	flex	incl. AC/DC Adaptor

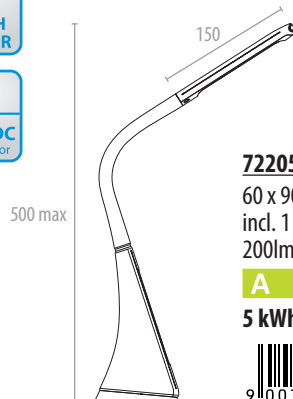

Kunststoff
plastic
plastique

incl. SMD LED

722050 ●
60 x 90 x 500 - VE/PU: 10
incl. 1 x 5 W - SMD-LED
200lm - 4000K - A+
A → 200lm
5 kWh/1000h - 5V DC



9 003348 159745

722051 ○
60 x 90 x 500 - VE/PU: 10
incl. 1 x 5 W - SMD-LED
200lm - 4000K - A+
A → 200lm
5 kWh/1000h - 5V DC



9 003348 159752

722052 ●
60 x 90 x 500 - VE/PU: 10
incl. 1 x 5 W - SMD-LED
200lm - 4000K - A+
A → 200lm
5 kWh/1000h - 5V DC



9 003348 159769



722054

722055

722056

722054 
 ↑ 610 · Ø 125 · VE/PU: 8
 incl. 1 x 5 W · SMD-LED
 400lm · 4000K · A+
A⁺ 400lm
 5 kWh/1000h · 5V DC



9 003348 143010

722055 
 ↑ 610 · Ø 125 · VE/PU: 8
 incl. 1 x 5 W · SMD-LED
 400lm · 4000K · A+
A⁺ 400lm
 5 kWh/1000h · 5V DC



9 003348 143027

722056 
 ↑ 610 · Ø 125 · VE/PU: 8
 incl. 1 x 5 W · SMD-LED
 400lm · 4000K · A+
A⁺ 400lm
 5 kWh/1000h · 5V DC



9 003348 143034



610 max

125



Kunststoff
plastic
plastique

incl. SMD  LED



720070



Holz • Glas
wood • glass
bois • verre

9W  E14 230V

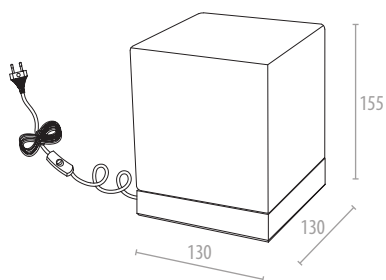

720070

130x130x155 • VE/PU: 18
1 x 9 W • E14-LED • 230V

A++ bis E





722046



722048

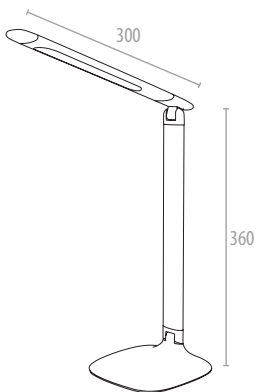

722046 ●
↑ 630 max • 145 x 145 • VE/PU: 8
incl. 1 x 5 W • SMD-LED • 220lm • 3000/4500/6000K • A

A → 840lm • 12 kWh/1000h • 5V DC



9 100334 811433 93

722048 ●
↑ 630 max • 145 x 145 • VE/PU: 8
incl. 1 x 5 W • SMD-LED • 220lm • 3000/4500/6000K • A

A → 840lm • 12 kWh/1000h • 5V DC



9 100334 811434 16

LED	ALU FRONT	6.000K 4.500K 3.000K	220 Lumen
TOUCH ON-OFF	TOUCH DIMMER	incl. AC/DC Adaptor	

Aluminium • Kunststoff
aluminium • plastic
aluminium • plastique

incl. SMD LED

BlueTooth

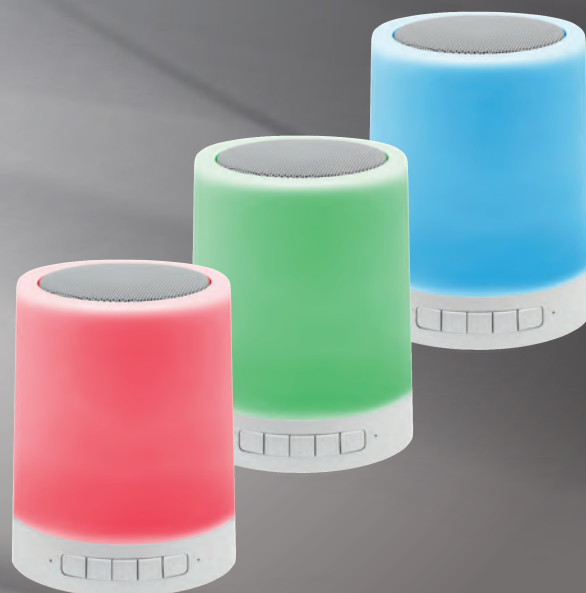

722040

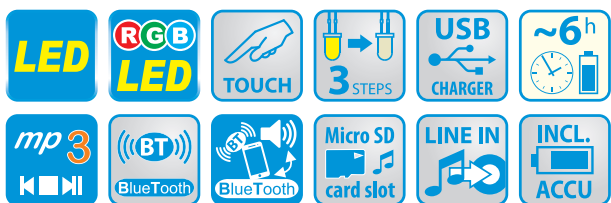

Metall • Kunststoff
metal • plastic
métal • plastique

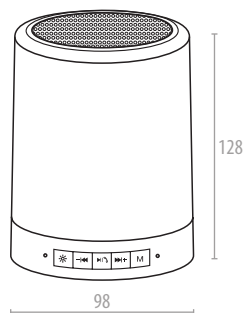
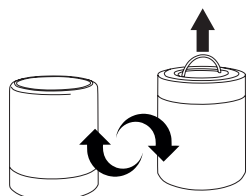
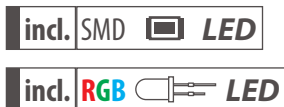

722040

Ø 98 - ↑ 128 - VE/PU: 12
incl. 1 x 0,8 W • SMD-LED • 80lm • 3000K • A+
incl. 1 x 0,8 W • RGB-LED

A+ 80lm • 2 kWh/1000h • 5V DC



9 003348 159691

BlueTooth



722002

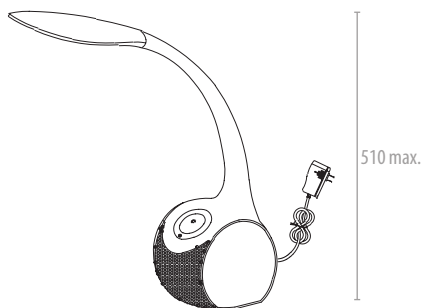

510 max.

722002

↑ 510 max. - 140 x 110 - VE/PU: 12
incl. 1 x 5 W - SMD-LED - 300lm - 4000K - A+
incl. 1 x 0,8W - RGB-LED

A+ 300lm - 5 kWh/1000h - 5V DC



9 1003348 1124156



Metall • Kunststoff
metal • plastic
métal • plastique

incl. SMD LED

incl. RGB LED



722003

722036

722037

722038

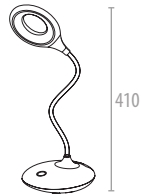

Kunststoff
plastic
plastique

incl. SMD LED

722003 ○
120 x 140 x 410 - VE/PU: 10
incl. 1 x 5 W - SMD-LED
220lm - 4000K - A

A 5 kWh/1000h - DC 12V



90033481551051

722036 ●
120 x 140 x 410 - VE/PU: 10
incl. 1 x 5 W - SMD-LED
220lm - 4000K - A

A 5 kWh/1000h - DC 12V



9003348157871

722037 ●
120 x 140 x 410 - VE/PU: 10
incl. 1 x 5 W - SMD-LED
220lm - 4000K - A

A 5 kWh/1000h - DC 12V



9003348157888

722038 ●
120 x 140 x 410 - VE/PU: 10
incl. 1 x 5 W - SMD-LED
220lm - 4000K - A

A 5 kWh/1000h - DC 12V



90033481578951



optional KOKO AC/DC adaptor

DC 5V
500mA



720030ED

EAN 9003348128345

720030

720031

720035

720034



KOKO

BELLO



720030 ○
↑ 470 max. • VE/PU: 30
incl. 1 x 3,2 W • SMD-LED
250lm • 4000K • A+

A+ 250lm
4 kWh/1000h • DC 5V



9 003348 157840

720031 ●
↑ 470 max. • VE/PU: 30
incl. 1 x 3,2 W • SMD-LED
250lm • 4000K • A+

A+ 250lm
4 kWh/1000h • DC 5V



9 003348 157857

720034 ○
↑ 470 max. • VE/PU: 30
incl. 1 x 3,2 W • SMD-LED
250lm • 4000K • A+

A+ 250lm
4 kWh/1000h • DC 5V



9 003348 158885

720035 ●
↑ 470 max. • VE/PU: 30
incl. 1 x 3,2 W • SMD-LED
250lm • 4000K • A+

A+ 250lm
4 kWh/1000h • DC 5V



9 003348 158892

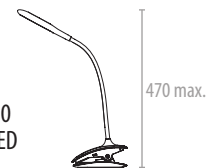

Kunststoff
plastic
plastique

incl. SMD LED



DISPLAY
clear • transparent



722018

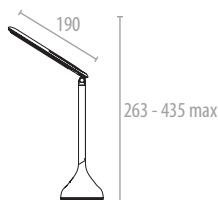

Kunststoff
plastic
plastique

incl. SMD LED

incl. RGB LED

722018

↑ 263 • Ø 87 • VE/PU: 8
incl. 1 x 4 W - SMD-LED - 253lm - 4000K - A+
incl. 1 x RGB-LED

A+ 253lm • 4 kWh/1000h • DC 5V



9 003348 156423

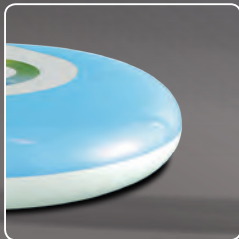
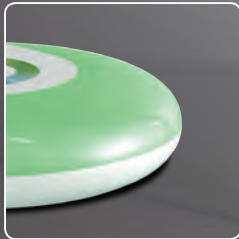

722025

722024

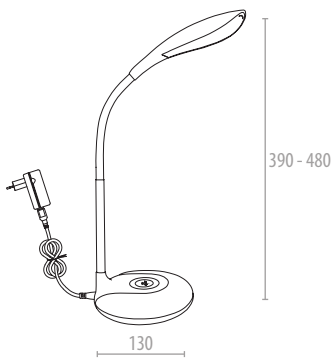

722025 ●
Ø 130 · ↑ 480 max. · VE/PU: 6
incl. 1 x 4 W · SMD-LED · 300lm · 4000K · A+
A+ 300lm · 4 kWh/1000h · DC 5V



9 003348 157833

722024 ●
Ø 130 · ↑ 480 max. · VE/PU: 6
incl. 1 x 4 W · SMD-LED · 300lm · 4000K · A+
A+ 300lm · 4 kWh/1000h · DC 5V



9 003348 157826

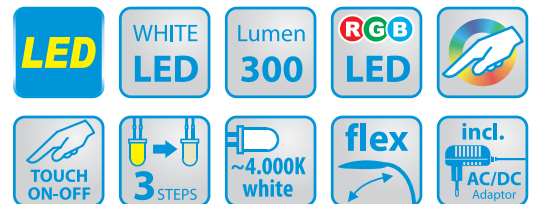

Kunststoff
plastic
plastique

incl. SMD LED

incl. RGB LED

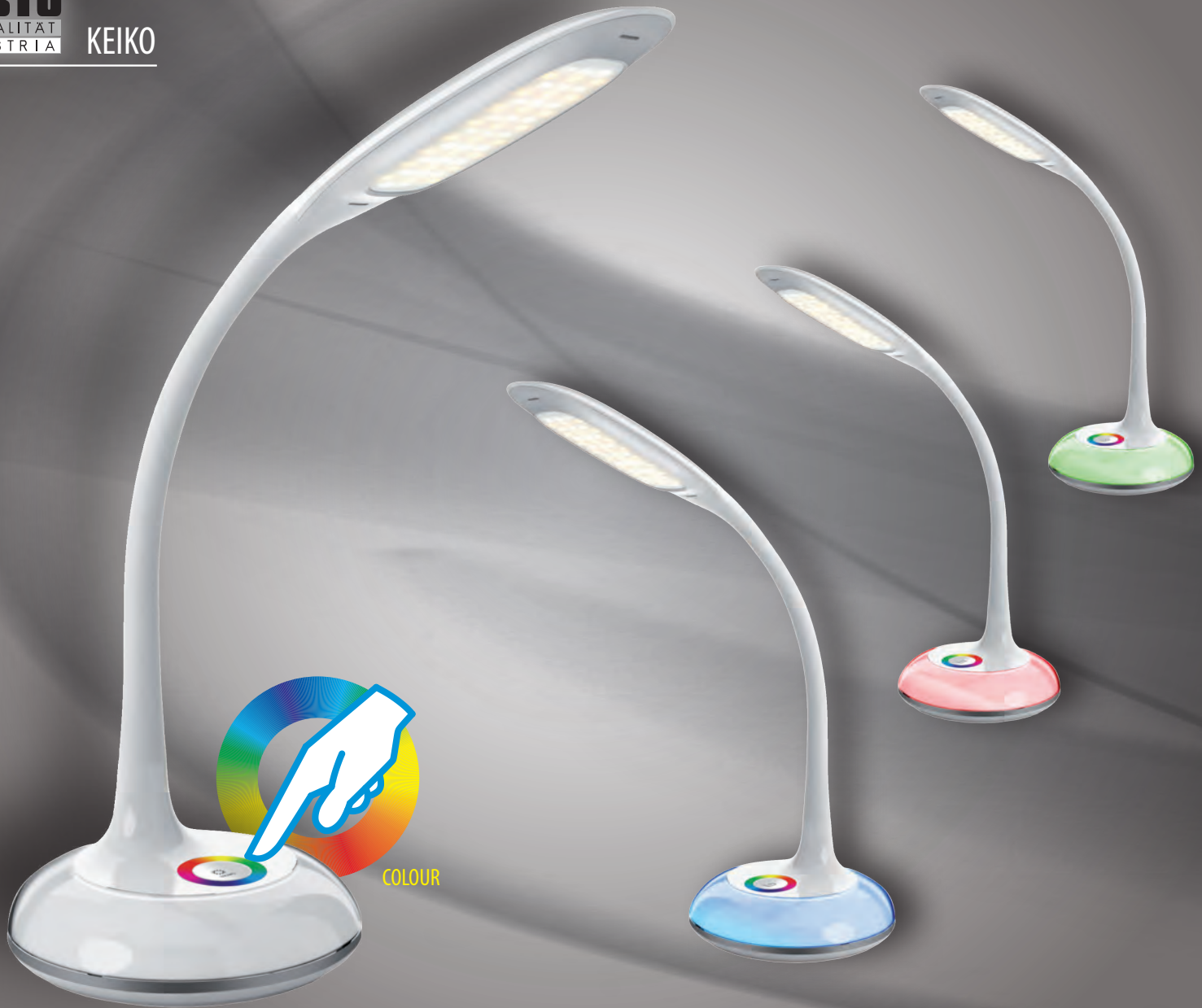

722004

LED	WHITE LED	Lumen 250	RGB LED	
	TOUCH ON-OFF	3 STEPS	~4.000K white	flex
			incl. AC/DC Adaptor	

Kunststoff
plastic
plastique

incl. SMD LED

incl. RGB LED

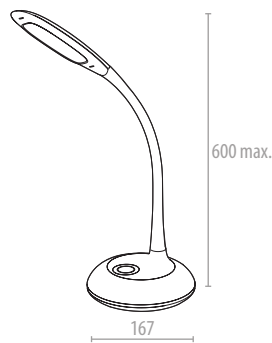

722004

Ø167 • ↑ 600 max. • VE/PU: 8
incl. 1 x 4,2 W • SMD-LED • 250lm • 4000K • A+
incl. RGB-LED • A+

A+ 250lm • 5 kWh/1000h • DC 5V



9 003348 110842 2



722005

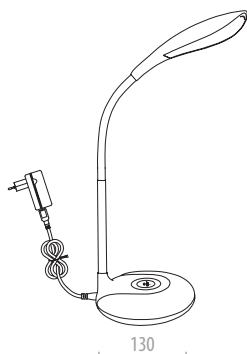

390 - 480

130

722005

Ø 130 - ↑ 480 max. - VE/PU: 12
incl. 1 x 4 W - SMD-LED - 300lm - 4000K - A+

A+ 300lm - 4 kWh/1000h - DC 5V



9 003348 154535

LED	WHITE LED	Lumen 300	RGB LED	
			flex	incl. AC/DC Adaptor

Kunststoff
plastic
plastique

incl. SMD LED

incl. RGB LED



9722036



Kunststoff
plastic
plastique

incl. SMD  LED

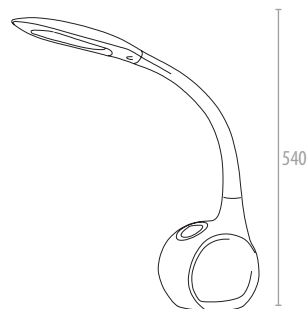

9722036

↑ 540 · VE/PU: 12
incl. 1 x 5 W · SMD-LED · 280lm · 5000K · A+

A+ 280lm · 5 kWh/1000h · DC 5V





720040



720041



720042

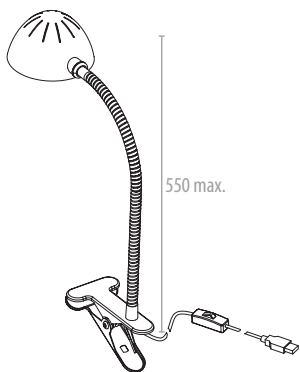

720040 ●
Ø 110 · ↑ 550 · VE/PU: 27
incl. 1 x 3 W · SMD-LED
170lm · 4000K · A+
A+ 170lm
3 kWh/1000h · 230V



9100334811433621

720041 ●
Ø 110 · ↑ 550 · VE/PU: 27
incl. 1 x 3 W · SMD-LED
170lm · 4000K · A+
A+ 170lm
3 kWh/1000h · 230V



9100334811433791

720042 ●
Ø 110 · ↑ 550 · VE/PU: 27
incl. 1 x 3 W · SMD-LED
170lm · 4000K · A+
A+ 170lm
3 kWh/1000h · 230V



9100334811433861



Metall · Kunststoff
metal · plastic
métal · plastique

incl. SMD LED



LED-TOUCHDIMMER
6 Stufen - 6 steps



722012

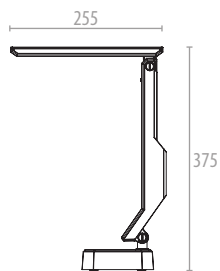

Kunststoff
plastic
plastique

722012

↑ 375 - ↔ 95 x 120 - VE/PU: 6
incl. 1 x 4,8 W - SMD-LED - 480lm - 4000K - A+

A+ 480lm - 5 kWh/1000h - DC 12V



9 003348 155921



722027

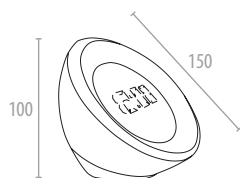

722027

Ø 150 · ↑ 100 · VE/PU: 12
incl. 1 x 3 W · SMD-LED · 240lm · A+ · 4000K
incl. 1 x 3 W · RGB-LED · A+

A+ 240lm · 6 kWh/1000h · DC 5V



9 003348 1158076



Kunststoff
plastic
plastique

incl. SMD LED

incl. RGB LED



722011

LED	TOUCH DIMMER	TOUCH ON-OFF
360°	WHITE LED	incl. AC/DC Adaptor

Kunststoff
plastic
plastique

incl. SMD LED

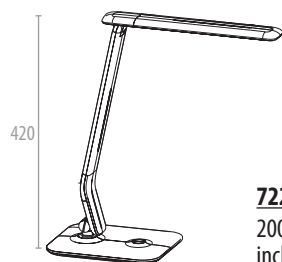

722011
200 x 155 x 420 - VE/PU: 6
incl. 1 x 7 W - SMD-LED - 500lm - 4000K - A+
A+ 500lm - 7 kWh/1000h - 12V



9 100334 811084 601



722006



722007

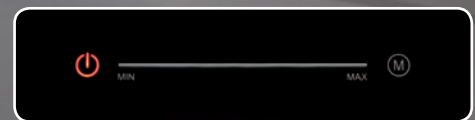

← DIMMER →

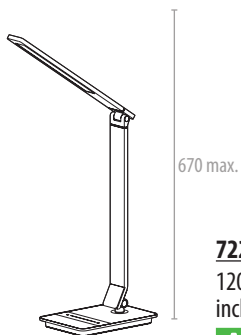

670 max.

722006 ●
120 x 180 - ↑ 670max. - VE/PU: 6
incl. 1 x 8 W - SMD-LED - 550lm - 3000/45000/6000K - A+
A+ 550lm - 8 kWh/1000h - 12V



9100334811084391

722007 ●
120 x 180 - ↑ 670max. - VE/PU: 6
incl. 1 x 8 W - SMD-LED - 550lm - 3000/45000/6000K - A+
A+ 550lm - 8 kWh/1000h - 12V



9100334811084461

LED	ALU FRONT	6.000K 4.500K 3.000K	550 Lumen
TOUCH ON-OFF	TOUCH DIMMER	270°	incl. AC/DC Adaptor

Aluminium • Kunststoff
aluminium • plastic
aluminium • plastique

incl. SMD LED



9722026



9722027



Kunststoff
plastic
plastique

incl. SMD LED

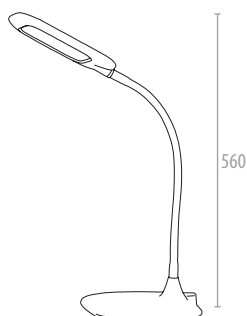

9722026 ○

↑ 560, 175 x 175 - VE/PU: 12
incl. 1 x 5 W - SMD-LED - 320lm - 5000K - A+

A+ 320lm - 5 kWh/1000h - 230V



9 003 34 81 144 16

9722027 ●

↑ 560, 175 x 175 - VE/PU: 12
incl. 1 x 5 W - SMD-LED - 320lm - 5000K - A+

A+ 320lm - 5 kWh/1000h - 230V



9 003 34 81 144 23



722001



722000

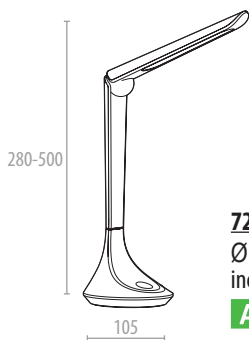

722000 ●
 Ø 105 • ↑ 280-500 • VE/PU: 24
 incl. 1 x 3,5 W • SMD-LED • 210lm • 4000K • A+
A+ → 210lm • 3,5 kWh/1000h • 5V



9 003348 11995 4

722001 ●
 Ø 105 • ↑ 280-500 • VE/PU: 24
 incl. 1 x 3,5 W • SMD-LED • 210lm • 4000K • A+
A+ → 210lm • 3,5 kWh/1000h • 5V



9 003348 11996 1

LED	210 Lumen	TOUCH ON-OFF	4000K colour white	INCL. ACCU
TOUCH- DIMMER	3 STEPS	incl. AC/DC Adaptor	USB CHARGER	~2 hours

Chrom • Kunststoff
 chrome • plastic
 chrome • plastique

incl. SMD LED



20046



20055



20051



20056

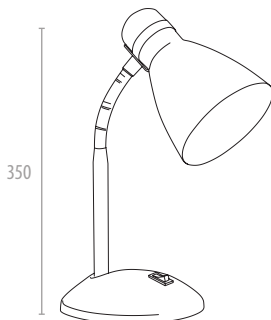

Metall • Chrom
metal • chrome
métal • chrome

40W E27 230V

20046
↑ 350 • VE/PU: 20
1 x 40 W • E27 • 230V

A++ bis E



20051
↑ 350 • VE/PU: 20
1 x 40 W • E27 • 230V

A++ bis E



20055
↑ 350 • VE/PU: 20
1 x 40 W • E27 • 230V

A++ bis E



20056
↑ 350 • VE/PU: 20
1 x 40 W • E27 • 230V

A++ bis E





20044



20043



992240



20042

20042 
↑ 350 - VE/PU: 20
1 x 40 W - E27 - 230V
A++ bis E



20043 
↑ 350 - VE/PU: 20
1 x 40 W - E27 - 230V
A++ bis E



20044 
↑ 350 - VE/PU: 20
1 x 40 W - E27 - 230V
A++ bis E



992240 
↑ 350 - VE/PU: 20
1 x 40 W - E27 - 230V
A++ bis E

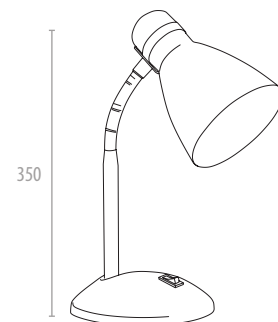

Metall • Chrom
metal • chrome
métal • chrome

40W  E27 230V



20060



20061

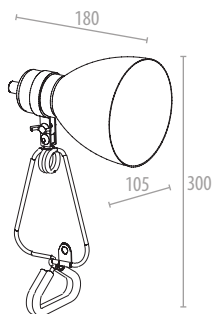

Metall • Chrom
metal • chrome
métal • chrome

40W E27 230V

20060 ○
Ø 105 • ↑ 300 • VE/PU: 16
1 x 40 W • E27 • 230V

A++ bis E



9 003348 159790

20061 ●
Ø 105 • ↑ 240 • VE/PU: 16
1 x 40 W • E27 • 230V

A++ bis E



9 003348 159806



20026



21002



21003



ALICE



20026
Ø 70 · ↑ 215 · VE/PU: 8
1 x 33 W · G9 · 230V

A++ bis E



Chrom · Glas
chrome · glass
chrome · verre

33W  G9 230V

CANDY

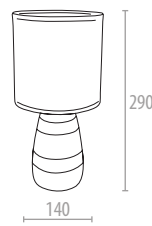

21002 ●
Ø 140, ↑ 290 · VE/PU: 24
1 x 25 W · E14 · 230V

A+



21003 ●
Ø 140, ↑ 290 · VE/PU: 24
1 x 25 W · E14 · 230V

A+



Keramik · Chintz
ceramic · chintz
céramique · chintz

40W - E14 230V



20500



20501



LIZ

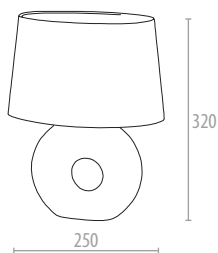

20500
250 x 150 • ↑ 320 • VE/PU: 12
1 x 25 W • E14 • 230V

A++ bis E



9 003348 112771

Steinoptik • Chintz
artificial stone • chintz
optique de pierre • chintz

25W E14 | 230V

WENDY

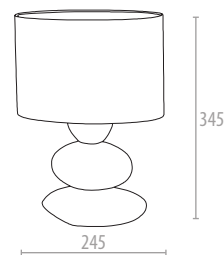

20501
245 x 150 • ↑ 345 • VE/PU: 12
1 x 25 W • E14 • 230V

A++ bis E



9 003348 112788



20502



20505



20506

20502 ●
155 x 155 - ↑ 285 - VE/PU: 12
1 x 25 W - E14 - 230V

A++ bis E



9 003348 112795 1

20505 ●
155 x 155 - ↑ 285 - VE/PU: 12
1 x 25 W - E14 - 230V

A++ bis E



9 003348 112650 1

20506 ●
155 x 155 - ↑ 285 - VE/PU: 12
1 x 25 W - E14 - 230V

A++ bis E



9 003348 112651 8

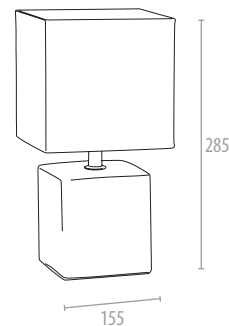

Keramik • Chintz
ceramic • chintz
céramique • chintz

25W E14 230V



20507



20508

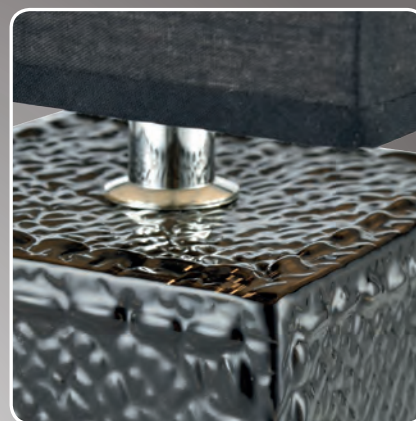

20509

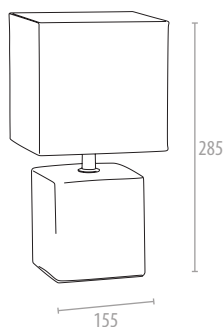

Keramik • Chintz
ceramic • chintz
céramique • chintz

25W E14 230V

20507 ●
155 x 155 • ↑ 285 • VE/PU: 12
1 x 25 W • E14 • 230V

A++ bis E



9 003348 114053 8

20508 ●
155 x 155 • ↑ 285 • VE/PU: 12
1 x 25 W • E14 • 230V

A++ bis E



9 003348 114164 1

20509 ●
155 x 155 • ↑ 285 • VE/PU: 12
1 x 25 W • E14 • 230V

A++ bis E



9 003348 114165 8



20521



20522

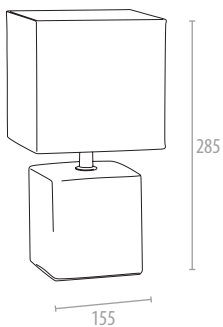

20521 ●
155 x 155 - ↑ 285 - VE/PU: 12
1 x 25 W - E14 - 230V
Keramik • Chintz
ceramic • chintz
céramique • chintz

A++ bis E



9 003348 114165 8

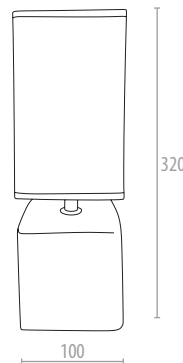

20522 ●
100 x 100 - ↑ 320 - VE/PU: 12
1 x 25 W - E14 - 230V
Holz • Chintz
wood • chintz
bois • chintz

A++ bis E



9 003348 114052 1



25W E14 230V



21100

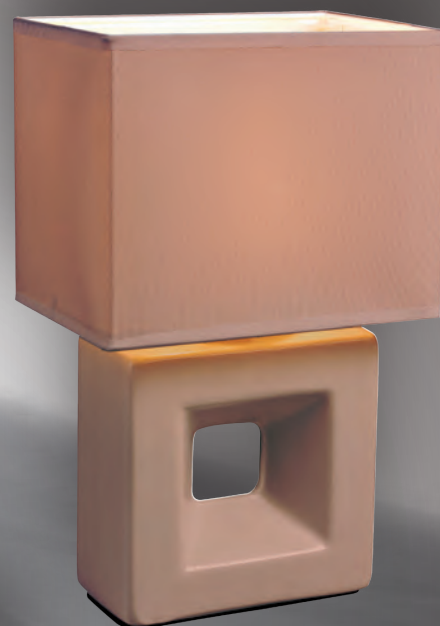

21102



21101

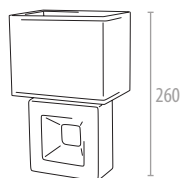

Keramik • Chintz
ceramic • chintz
céramique • chintz

25W E14 230V

21100 ●
150 x 100 x 260 - VE/PU: 24
1 x 25 W - E14 - 230V

A++ bis E



9 003348 119916

21101 ●
150 x 100 x 260 - VE/PU: 24
1 x 25 W - E14 - 230V

A++ bis E



9 003348 119923

21102 ●
150 x 100 x 260 - VE/PU: 24
1 x 25 W - E14 - 230V

A++ bis E



9 003348 119930



990413

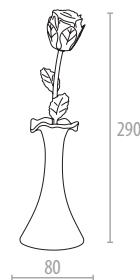
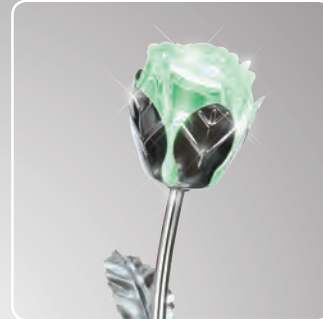

990413
↑ 290 - Ø 82 - VE/PU: 30
incl. 1 x 0,1 W - LED Multicolour

A+ 1 kWh/1000h - 4,5V



Chrom • Kunststoff
chrome • plastic
chrome • plastique

incl. RGB LED

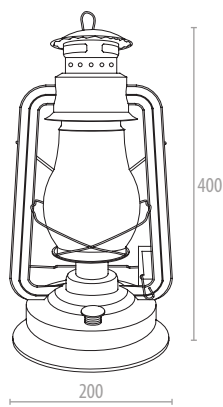

900518
Ø 200 - ↑ 400 - VE/PU: 8
1 x 25 W - E27 - 230V
Metall - Glas
metal - glass
métal - verre

A++ bis E

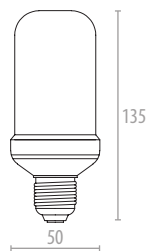

900519
Ø 55 x 130 - VE/PU: 100
1 x 5 W - E27 - 180lm - 1400K - 150lm
Metall - Kunststoff
metal - plastic
métal - plastique

A 180lm - 5 kWh/1000h - 230V



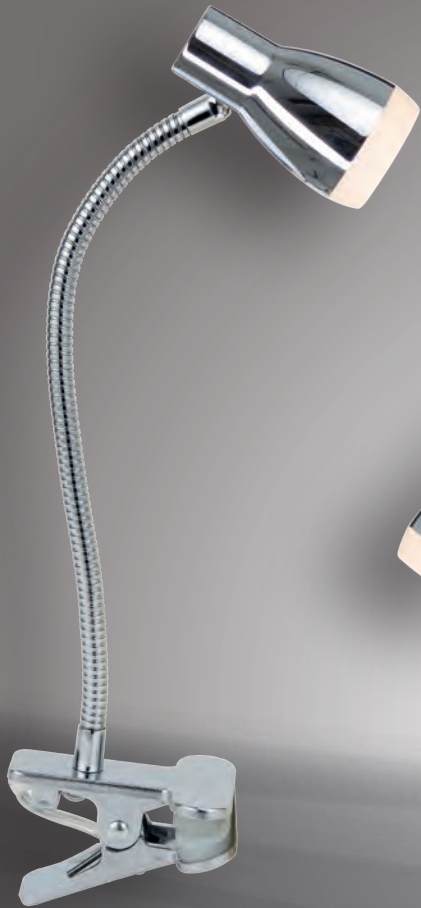

762045-1



762046-1



762047-1

i „JOY“
Spotleuchten • spot-
lights • spots

4.07

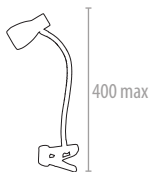

762045-1

↑ 400 • VE/PU: 12
incl. 1 x 4 W • SMD-LED • 350lm • 3000K • A+

A+ 350lm • 4 kWh/1000h • 230V



9 003348 159349



762046-1

Ø 120 • ↑ 400 • VE/PU: 6
incl. 1 x 4 W • SMD-LED • 350lm • 3000K • A+

A+ 350lm • 4 kWh/1000h • 230V



9 003348 159356

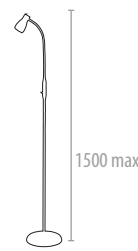

762047-1

Ø 200 • ↑ 1500 • VE/PU: 6
incl. 1 x 4 W • SMD-LED • 350lm • 3000K • A+

A+ 350lm • 4 kWh/1000h • 230V



9 003348 159363



Metall • Chrom • Acryl
metal • chrome • acrylic
métal • chrome • acrylique

incl. SMD LED



720017

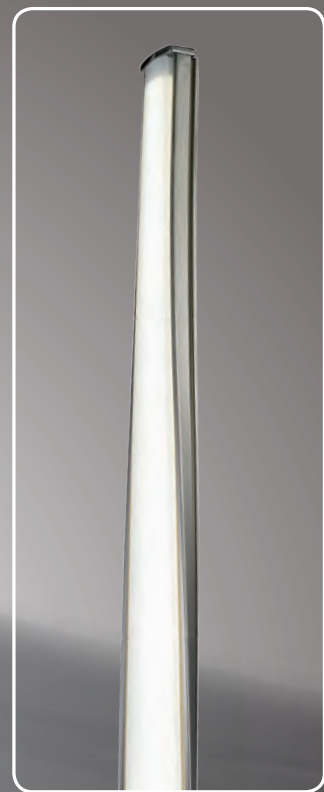

780162



„SINUS“ Deckenleuchten • ceiling lamps •
plafonniers



3.55



SINUS

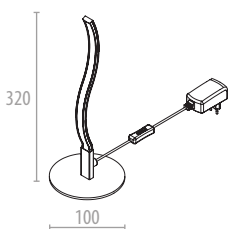

720017

Ø 110 • ↑ 320 - VE/PU: 10
incl. 1 x 3,6 W • SMD-LED Stipe • 360lm • 3000K • A++

Aluminium • Acryl
aluminium • acrylic
aluminium • acrylique

incl. SMD LED

A++ 360lm • 4 kWh/1000h • 230V



9 003348 1154511



PRISTINE

780162

Ø 160 • ↑ 1200 - VE/PU: 12
incl. 1 x 12 W • SMD-LED • 960lm • 4000K • A+

Stahl gebürstet • Acryl
metal brushed • acrylic
métal brossé • acrylique

incl. SMD LED

A+ 960lm • 12 kWh/1000h • 230V



9 003348 1121568

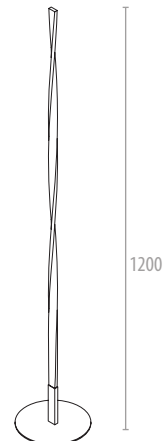



926048

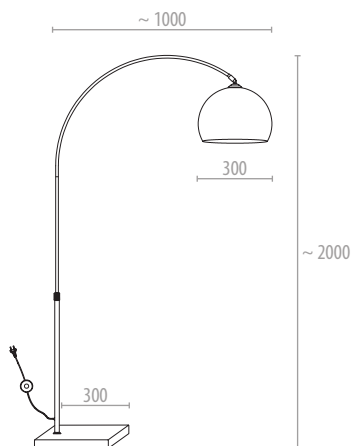
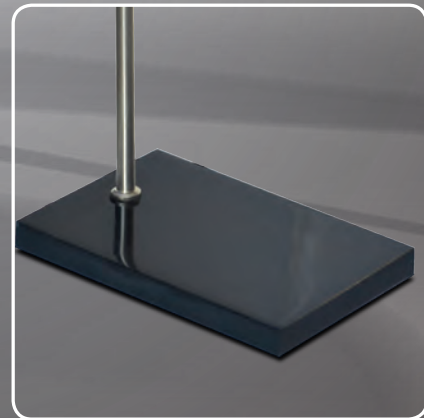

926048
↑ 2000 • ↔ 1000 • VE/PU: 2
1 x 60 W - E27 - 230V

A++ bis E



Stahl gebürstet • Kunststoff • Stein
metal brushed • plastic • stone
métal brossé • plastique • pierre

60W E27 230V

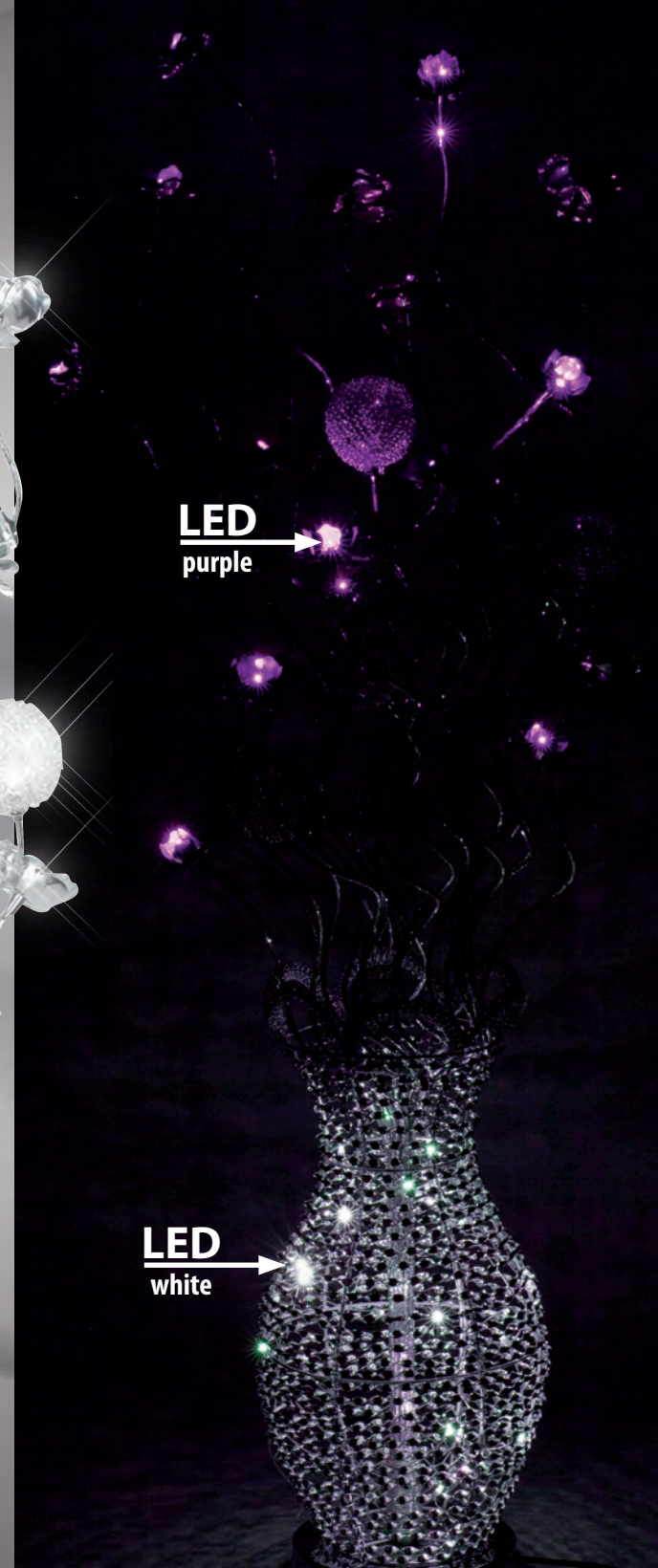

LED
purple

LED
white

83433-5



Aluminium • Chrom
aluminium • chrome
aluminium • chrome

20W G4 12V

incl. LED LED



83433-5

↑ 1600 - VE/PU: 1
5 x 20 W - G4 - 12V

incl. 64 x 0,08 W - 48 x LED white - 16 x purple

A++ bis E



9100334818994291



1600

CRYSTAL PIPE

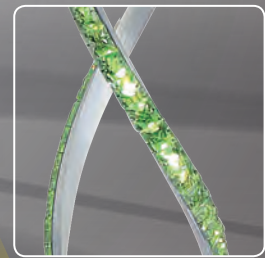
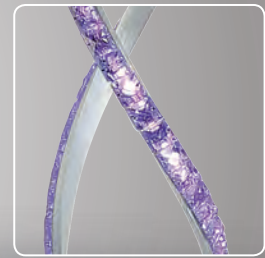
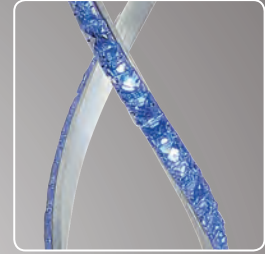
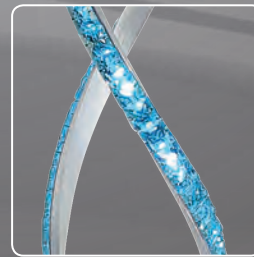
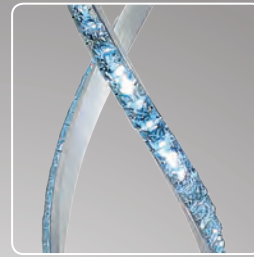

7 colours



i „AMADO“
Pendelleuchte •
pendant lamp •
suspension

1.11

724030

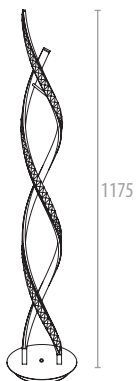

724030

↑ 1175 • Ø 200 • VE/PU: 1
incl. 1 x 14 W • RGBW-LED • 1120lm • 4000K • A+

A+ 1120lm • 14 kWh/1000h • 230V



Stahl gebürstet • Chrom • Glas
metal brushed • chrome • glass
métal brossé • chrome • verre

incl. **RGB + W** **LED**



726005

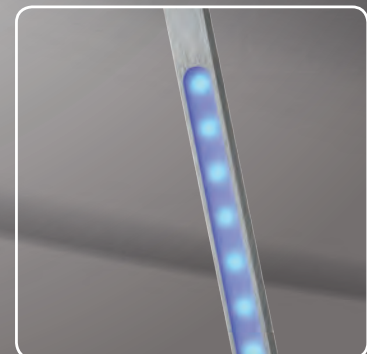
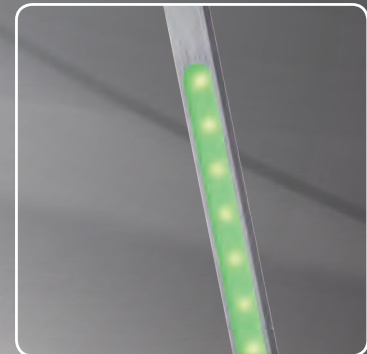
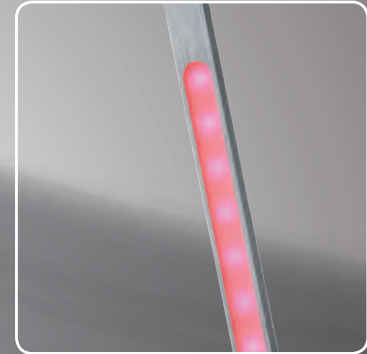

Aluminium gebürstet • Chrom
aluminium brushed • chrome
aluminium brossé • chrome

incl. SMD LED

incl. RGB LED

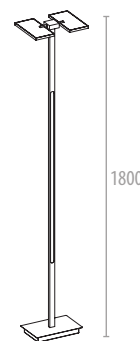

726005

↑ 1800 • ↔ 230 x 330 • VE/PU: 1
incl. 1 x 28 W • SMD-LED • 2240lm • 3000K • A
incl. 1 x 5,4 W • RGB-LED • A+

A 2240lm • 34 kWh/1000h • 230V



9 003348 155587



726029



726020



726021

MARIUS

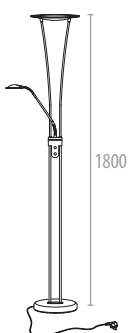

726029

↑ 1800 - Ø 300 - VE/PU: 1
incl. 1 x 20 W - SMD-LED - 1800lm - 3000K - A+
incl. 1 x 4 W SMD-LED - 360lm - 3000K - A+
Stahl gebürstet - Acryl
metal brushed - acrylic
métal brossé - acrylique

A+ 2160lm

24 kWh/1000h - 230V



DOMINIC

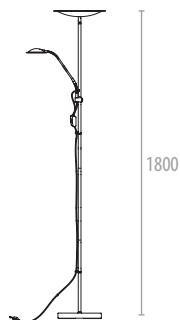

726020

↑ 1800 - Ø 254 - VE/PU: 1
incl. 1 x 18 W - SMD-LED1620lm - 3000K - A+
incl. 1 x 6 W SMD-LED - 540lm - 3000K - A+
Metall weiß - Acryl
metal white - acrylic
métal blanc - acrylique

A+ 2160lm

24 kWh/1000h - 230V



726021

↑ 1800 - Ø 254 - VE/PU: 1
incl. 1 x 18 W - SMD-LED1620lm - 3000K - A+
incl. 1 x 6 W SMD-LED - 540lm - 3000K - A+
Stahl gebürstet - Acryl
metal brushed - acrylic
métal brossé - acrylique

A+ 2160lm

24 kWh/1000h - 230V



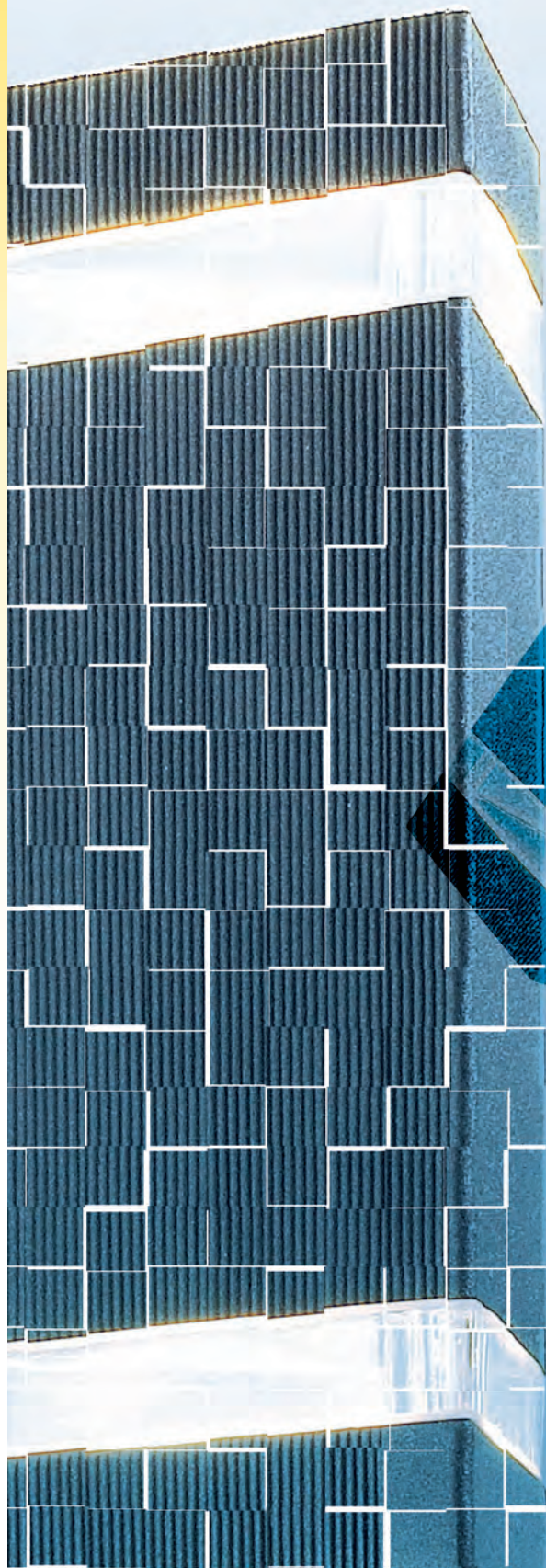

07

Außenleuchten
outdoor lights
luminaires extérieurs

ESTERNA

03

Aluminium • Glas
aluminium • glass
aluminium • verre

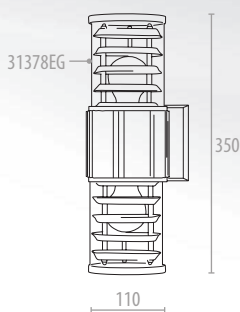

31378-2
Ø 110 x 350 - VE/PU: 10
2 x 60 W - E27 - 230V
60W E27 230V

A++ bis E

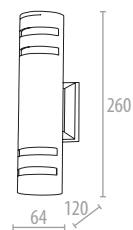

31382-2
64 x 120 x 260 - VE/PU: 20
2 x 40 W - E14 - 230V
40W E14 230V

A++ bis E



31383-2
110 x 130 x 230 - VE/PU: 10
2 x 35 W - GU10 - 230V
35W GU10 230V

A++ bis E



31378-2

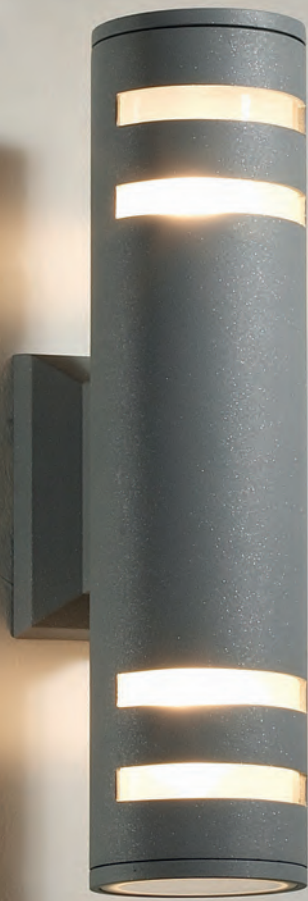

31382-2

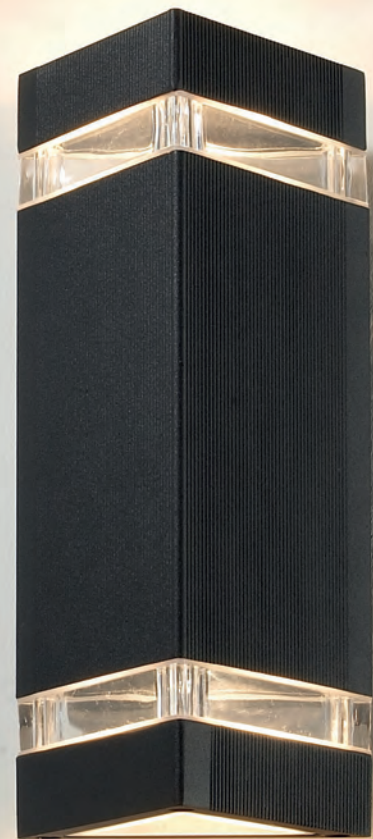

31383-2



LED LINE CONNECT

03

08

Technisches Licht

technical lights

lumiere technique



60cm LED CONNECT

Aluminium • Kunststoff
aluminium • plastic
aluminium • plastique

incl. SMD LED

123x LED

10W 700lm

3.000K warm white

5 min

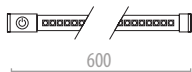

79300 Set 1
↔ 600 - VE/PU: 16
incl. 1 x 10 W - SMD-LED Board
700lm - 3000K - A+
A+ 700lm
10 kWh/1000h - 230V



79301 Set 2
↔ 600 - VE/PU: 24
incl. 1 x 10 W - SMD-LED Board
700lm - 3000K - A+
A+ 700lm
10 kWh/1000h - 230V



Set 1 | **Set 2** | **Set 2**
10W + 10W + 10W
3 x 10W max.!

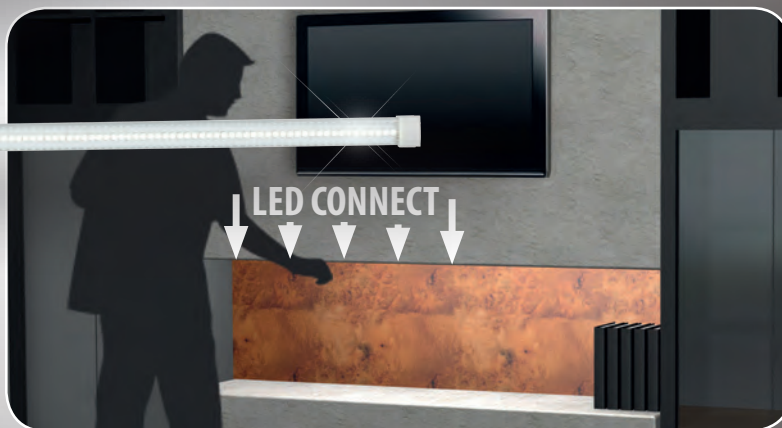
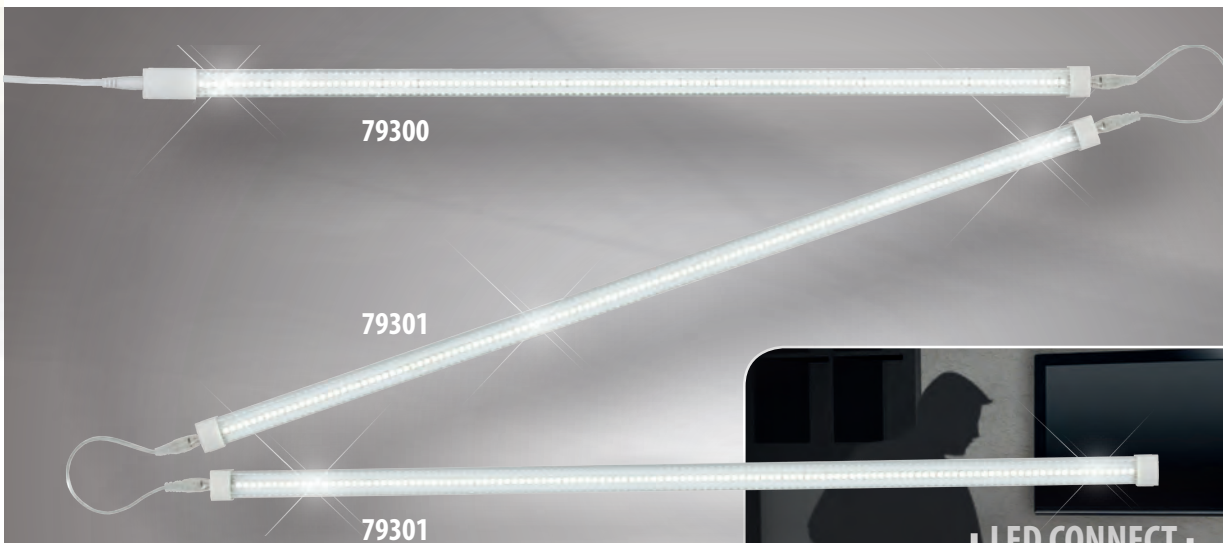
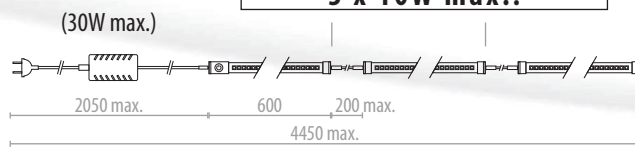

Set 1

79300

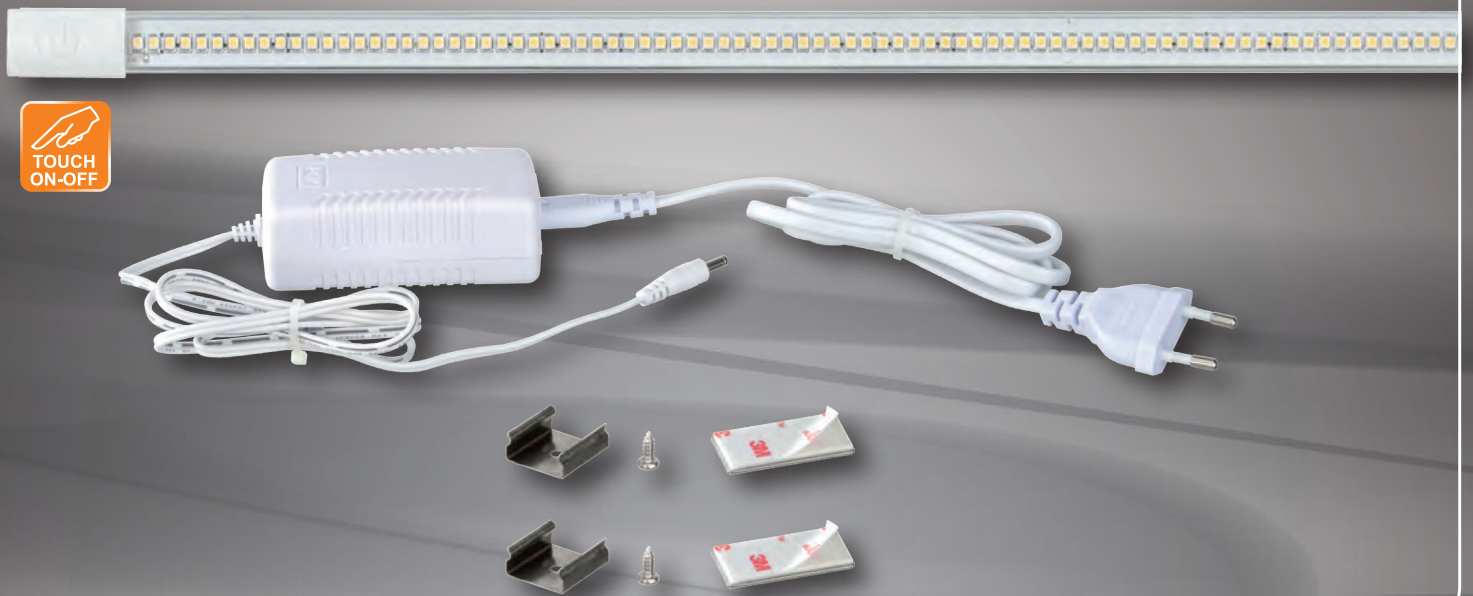

Set 2

79301

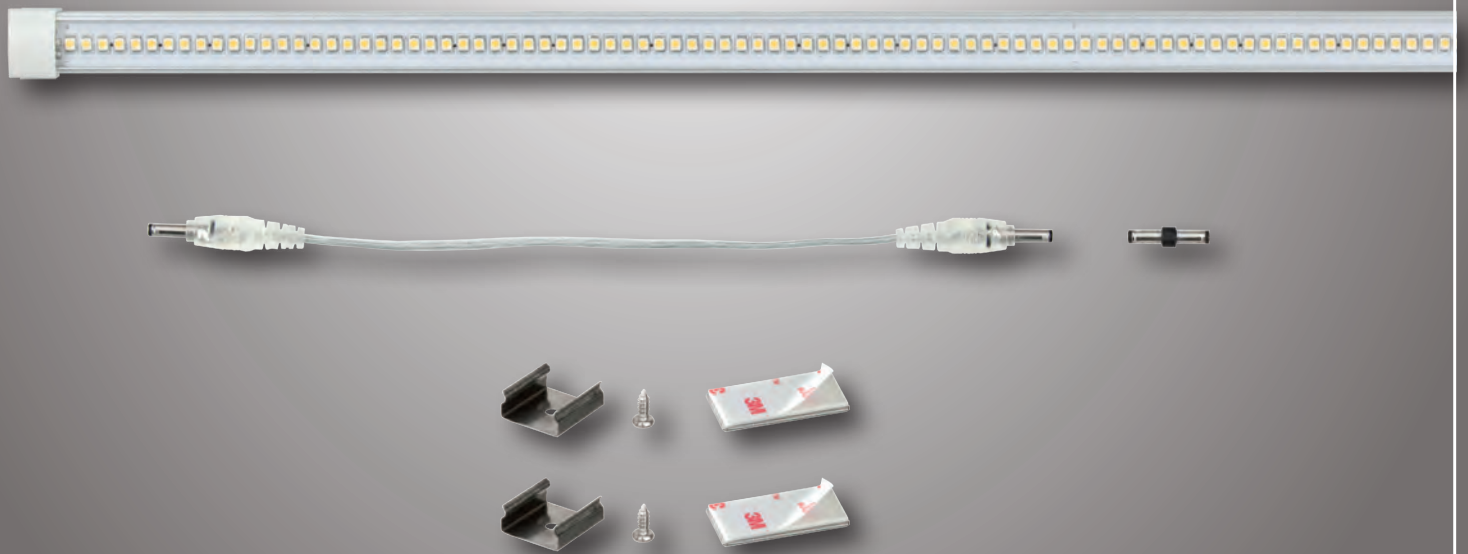



www.esto.at • office@esto.at

ESTO Lighting GmbH • 9220 Velden / Lind • Jessenigstraße 2 • AUSTRIA

Tel. +43 / (0) 4274 / 3133-0 • Fax +43 / (0) 4274 / 51359

ESTO Prospekte • ESTO leaflets • dépliants ESTO

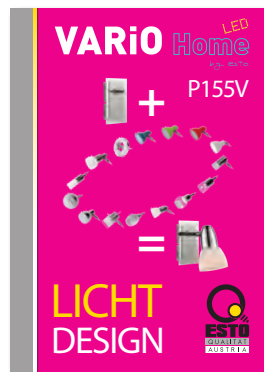

VARiO Home LED
P157V

by esto

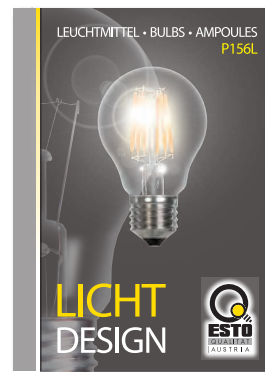

ESTO bulbs
P157L

INHALT • CONTENT • SOMMAIRE



Art.Nr. ref.no.	Seite page
15000	01.10
15034	01.23
15068	01.08
15069	01.08
15076	01.07
15078	01.09
15605	01.31
15606	01.31
15666	01.25
15667	01.25
15671	01.25
15672	01.25
15679	01.25
15685	01.26
15686	01.26
15687	01.26
15688	01.26
15689	01.26
15982	01.29
15983	01.29
15984	01.30
16145-1	01.17
16145-3	01.18
16147	01.17
16151	01.19
16152-1	01.19
16152-3	01.19
16165	01.20
16166-3	01.20
16185-1	01.15
16185-3	01.16
16186-1	01.15
16187	01.16
16188-1	01.15
17019	01.21
17020	01.21
17054	01.10
173001	01.27
173008	01.27
18020	01.05
18021	01.05
18024	01.06

Art.Nr. ref.no.	Seite page
18025	01.06
18026	01.06
18102	01.03
18104	01.04
18105	01.04
20000	01.10
20026	06.26
20042	06.24
20043	06.24
20044	06.24
20046	06.23
20051	06.23
20055	06.23
20056	06.23
20060	06.25
20061	06.25
20500	06.27
20501	06.27
20502	06.28
20505	06.28
20506	06.28
20507	06.29
20508	06.29
20509	06.29
20521	06.30
20522	06.30
21002	06.26
21003	06.26
21100	06.31
21101	06.31
21102	06.31
31378-2	07.03
31382-2	07.04
31383-2	07.04
40037	03.41
40038	03.41
41561	03.45
41562	03.45
41585	03.40
41586	03.40
41600-3	02.23
41600-4	02.23

Art.Nr. ref.no.	Seite page
41605-4	02.24
42003-4	04.37
42003-6	04.38
42006-12	03.54
42006-14	03.54
42025-5	03.57
43020	05.03
43022	05.03
43023	05.03
43024	05.03
43025	05.03
48114	03.48
50000-1	04.41
50000-2	04.42
50000-3	04.42
50000-4	04.42
50010-4	03.48
53698-2	03.71
60018-1	04.04
60018-2	04.04
60018-3	04.04
60018-4	04.03
60710-1	04.40
60710-2	04.40
60710-3	04.40
60710-4	04.40
60710-6	04.39
60750-1	03.63
60750-2	03.63
60750-3	03.63
60750-5	03.64
60750-6	03.64
63170-2	02.29
63170-5	02.30
63171	02.30
63173-2	02.31
70001-1	02.17
70001-2	02.18
70001-3	02.18
70002-1	02.19
70002-2	02.20
70002-3	02.20

Art.Nr. ref.no.	Seite page
70005-4	02.22
70005-6	02.22
70007-3	02.27
70007-4	02.27
70010-1	02.28
70010-5	02.28
70020-5	02.03
70020-7	02.04
70100	02.05
70101	02.05
70102-5	02.06
70110	02.11
70112	02.11
70115	02.12
70117	02.12
70118	02.12
70119	02.12
70121	02.13
70127	02.14
70128	02.14
70130	02.07
70132	02.07
70133	02.07
70135	02.08
70137	02.08
70138	02.08
70139	02.08
70142	02.15
70145	02.15
70146	02.15
70147	02.16
70148	02.16
70149	02.16
70151	02.09
70152-5	02.10
70159	02.09
710002	05.04
710060	01.12
710062	01.12
711005	01.11
720017	06.35
720030	06.10

Art.Nr. ref.no.	Seite page
720030ED	06.10
720031	06.10
720034	06.10
720035	06.10
720040	06.16
720041	06.16
720042	06.16
720070	06.05
722000	06.22
722001	06.22
722002	06.08
722003	06.09
722004	06.13
722005	06.14
722006	06.20
722007	06.20
722011	06.19
722012	06.17
722018	06.11
722024	06.12
722025	06.12
722027	06.18
722036	06.09
722037	06.09
722038	06.09
722040	06.07
722046	06.06
722048	06.06
722050	06.03
722051	06.03
722052	06.03
722054	06.04
722055	06.04
722056	06.04
724030	06.38
726005	06.39
726020	06.40
726021	06.40
726029	06.40
740004-1	03.25
740004-2	03.26
740004-4	03.26

Art.Nr. ref.no.	Seite page
740004-9	03.26
740013-1	03.39
740013-2	03.39
740013-4	03.39
740018-1	03.23
740018-2	03.24
740018-4	03.24
740038-1	03.19
740038-4	03.20
740038-9	03.19
740039-4	03.20
740044-1	03.17
740044-2	03.18
740044-4	03.18
740072-1	03.21
740072-2	03.22
740072-4	03.22
740098-1	03.61
740098-2	03.62
740098-3	03.61
740098-4	03.62
740098-6	03.61
740106-9	03.38
740115	03.16
741004	03.09
741005	03.09
742002-6	05.26
742003-1	05.26
742003-5	05.25
742010-1	03.59
742010-3	03.59
742010-5	03.60
742010-6	03.58
742011-2	03.60
742011-4	03.60
742014	03.55
742015	03.55
742034-4	03.56
742036-4	03.56
742038-4	03.49
742038-6	03.49
742038-9	03.50

Art.Nr. ref.no.	Seite page
742046-2	03.53
742068-6	03.50
744000-2	03.72
745010	03.76
745011	03.76
745012	03.76
745034	03.80
745035	03.80
745040	03.75
745041	03.75
745043-1	03.73
745045	03.79
745050	03.77
745051	03.77
745052	03.77
746000	03.08
746001	03.08
746021	03.9
746030	03.07
746031	03.07
746042	03.14
746043	03.14
746046	03.14
746052	03.03
746054	03.04
746055	03.04
746067	03.11
746068	03.11
746069	03.11
746090	03.12
746091	03.12
747003	03.05
747004	03.05
747005	03.05
748011-5	03.27
748060	03.37
748061	03.37
748063	03.37
749001-6	03.34
749005	03.82
749006	03.81
749007	03.82

Art.Nr. ref.no.	Seite page
749010	03.82
749029-5	03.28
749062-4	03.35
749066	03.06
749067	03.06
749091-5	03.30
749191-6	03.31
749203	03.10
749204	03.10
749240	03.15
749241	03.15
749242	03.16
749245	03.13
749246	03.13
749248	03.13
760003-1	04.30
760003-2	04.30
760003-3	04.30
760003-4	04.29
760004-1	04.34
760004-2	04.34
760004-3	04.33
760004-4	04.33
760004-6	04.34
760008-1	04.45
760008-2	04.46
760008-3	04.45
760008-4	04.46
760008-6	04.46
760016-1	04.36
760016-2	04.36
760016-3	04.36
760016-4	04.35
760017-1	04.06
760017-2	04.06
760017-3	04.06
760017-4	04.05
760044-1	04.27
760044-2	04.28
760044-3	04.28
760044-4	04.28
760050-1	04.43

Art.Nr. ref.no.	Seite page
760050-2	04.44
760050-3	04.43
760050-4	04.44
760050-6	04.44
762002-1	04.23
762002-2	04.24
762002-3	04.23
762002-4	04.24
762017-1	04.20
762017-2	04.20
762017-3	04.20
762017-4	04.20
762017-6	04.19
762020-1	04.14
762020-2	04.14
762020-3	04.14
762020-4	04.14
762020-6	04.13
762026-4	04.12
762027-1	04.10
762027-2	04.10
762027-3	04.10
762027-4	04.10
762027-6	04.09
762029-1	04.12
762029-2	04.12
762029-3	04.12
762029-4	04.12
762029-6	04.11
762032-1	04.31
762032-2	04.32
762032-3	04.32
762032-4	04.32
762036-1	04.21
762036-2	04.22
762036-3	04.22
762036-4	04.21
762040-1	04.16
762040-2	04.16
762040-3	04.16
762040-4	04.16
762040-6	04.15

Art.Nr. ref.no.	Seite page
762042-3	04.26
762042-4	04.26
762043-4	04.25
762044-1	04.08
762044-2	04.08
762044-3	04.08
762044-4	04.08
762044-6	04.07
762045-1	06.34
762046-1	06.34
762047-1	06.34
762049-1	04.18
762049-2	04.18
762049-3	04.18
762049-4	04.18
762049-6	04.17
762060-1	05.16
762060-2	05.16
762060-3	05.16
762060-4	05.15
762062-6	05.14
762064-3	05.13
780012-8	03.51
780055-5	05.10
780057	05.09
780086	05.24
780087	05.23
780088	05.23
780105	01.13
780106	01.14
780150A	05.22
780151A	05.22
780152A	05.21
780162	06.35
780194-2	05.18
780195-2	05.17
780196-2	05.17
780200	05.20
780201	05.20
780202	05.19
780221-5	05.08
780224	05.07

Art.Nr. ref.no.	Seite page
780226-2	05.12
780227-2	05.12
780229-2	05.11
780250	05.06
780253	05.06
780256	05.05
79300	08.03
79301	08.03
80012-8	03.52
83433-5	06.37
900518	06.33
900519	06.33
914001	01.23
914005	01.23
914092	01.24
914093	01.24
926048	06.36
940032-5	03.33
947044	03.44
947045	03.44
970101-6	02.24
9722026	06.21
9722027	06.21
9722036	06.15
9740019	03.36
9749196-8	03.32
9760012-1	04.47
9760012-2	04.48
9760012-3	04.48
9760013-6	04.48
980074-1	03.65
980074-2	03.66
980074-3	03.66
980074-4	03.66
980079-1	03.67
980079-2	03.67
980079-3	03.68
980079-4	03.67
980079-6	03.68
990413	06.32
991408	01.32
991409	01.32

Art.Nr. ref.no.	Seite page
991430	01.22
991431	01.22
991469	01.30
991478	01.30
992240	06.24
994075	03.46
994076	03.46
994077	03.46
994078	03.46
994700	03.78
994701	03.78
994702	03.78
994706	03.42
994708	03.43
994709	03.43
994770	03.47
994771	03.47
994800	03.74
994801	03.74
994808	03.43
994809	03.43
997040-2	02.32
997106-1	02.25
997106-3	02.25
997106-4	02.25
997118-5	02.26
997119-5	02.26
998039-3	03.70
998040-3	03.69
998040-5	03.69
998057-6	03.58
998070-8	03.29
998090-5	03.29

Serie • series • série	Seite page
ACRYLIC	01.23
ALBA	03.46
ALICE	06.26
AMADO	01.11
AMIDA	06.03
AMIRA	05.09
ARION	05.19
AVEO	03.21
BALENO	03.25
BALLINA	01.22
BARRETTE	03.76
BELLA LED	06.37
BELLO	06.10
BELT	03.80
BIRDY	01.20
BRAVO	04.17
BURL	01.07
CAMARA	03.49
CANDY	06.26
CARME	01.12
CAROLINA	03.58-60
CHROMO	03.71

Serie • series • série	Seite page
CINDY	02.24
CLASSIK	02.29-31
CLIVIA	04.39
CLOCK	06.18
COLORSTAR	04.25
COMBO	05.13-16
COOKE	01.03
CORSO	04.11
COSMO	01.19
CRISTALLO	03.42-43
CRYSTAL PIPE	06.38
CRYSTALLITE	03.33
CUBE	06.05
CURVE	03.74 / 06.36
DECENT	05.03
DELILA	05.11
DIAMOND	01.13
DIGGER	06.17
DIMMER	03.79
DION	03.05
DOMINIC	06.40
DOMINIC	06.40

Serie • series • série	Seite page
DOMINO	03.17
ELEGANCE	03.31
ELENA EVO	03.67
ELINA	03.39
ELVO	04.45
ERICA	06.31
ESTERNA	07.03
ESTERNA	07.04
FANTASIA	01.29
FEELING	03.36
FERRARA	02.13
FIORINA	06.32
FLEXY	06.16
FLOWER POWER	03.47
GEMINI	03.44
GINA	03.58
HELSINKI	01.32
JARON	01.15
JARON	01.15 / 04.03
JASON	03.53
JASPIS	03.32
JIRO	06.06

Serie • series • série	Seite page
JOY	04.08 / 06.34
KAIRO	02.11
KEIKO	06.08
KEIKO	06.12 / 13-15
KEVIN	01.24
KIANA	03.28
KING	04.23
KOKO	06.10
KOLEOS	05.25
KRISTALL	03.29
KRISTIN	03.34
LANTERN	06.33
LARISSA	03.35
LAYER	03.37
LED CONNECT	08.03
LIANA	04.41
LILLY	01.05
LINE	05.21
LIZ	06.27
LOTUS	03.03
LUMA	03.77
LUMA	03.77

Serie • series • série	Seite page
LUNEA	03.11
LYRIC	04.33
MAGIC	04.05
MAGMA	03.61
MARINA	03.75
MARIUS	06.40
MESSINA	02.15
MESSINA VANILIA	02.07-10
METROPOL	03.40
MICON	04.19
MIKA	06.22
MILENA	01.25-27 / 31
MIO	06.19
MODUS	04.43
MOON	03.45
NATALIA	01.04
NELIS	03.23
NERO	04.09
NIZZA	02.05
NOREEN	05.05
OHARA	03.51
OLIVE	01.09

Serie • series • série	Seite page
ORIENT	01.10
ORION	03.78
ORNAMENT	03.41
ORNAMENT	03.41
PAVO	04.35
PEARL	03.63
PERLA	01.21
PICTURE LIGHT	03.81
POLAR	03.04
PRIMA	03.07
PRINCE	04.21
PRISTINE	06.35
PROTEUS	03.08 / 13 / 15
PROVENCE ECO	02.32
RIKU	06.09
RITA	03.19
ROMANTICA	02.22 / 25-27
ROMINA	03.27
RUBY	04.29
SATELLITE	03.54
SAYO	06.04
SCALY	01.23

Serie • series • série	Seite page
SEMIC	04.15
SERENA	03.65
SILUR	05.07
SINUS	03.55 / 06.35
SOFT	03.09
SOUND	06.07
SPACY	03.06
SPARK	03.73
SPIRA	03.57
SQUARE	04.13
STARLIGHT	03.12 / 14
STELLAR	01.17
STEREO	03.72
STUDIO	06.23-25
SUNNY	03.48
SWIRL	01.08
SWORD LED	05.23
TAURUS	03.70
THERESA	02.03
TORRO	03.69
UFO LED	04.47
VEGAS	06.39

Serie • series • série	Seite page
VENETA	02.24
VENEZIA	02.17-20
VERENA	04.37
VERUS	04.31
VIOLA	02.23
WANDA	06.28-30
WAVE LINE	05.17
WAVER	04.27
WEGA MC	03.10
WENDY	06.27
WIRE	01.06
XILO	03.38
YOKO	06.21
YUI	06.11
YUNA	06.20
ZOO	03.48

SYMBOLERKLÄRUNG · DECLARATION OF SYMBOLS · DECLARATION SYMBOLE



Mehrere Funktionen über Schalter im Artikel oder in der Wand zu Schalten.
Choose different functions with switch in item or wall.
3 fonctions différentes par l'interrupteur sur le luminaire ou mural.



Inklusive Fernbedienung.
Remote control included.
Télécommande inclus.



Mehrere Funktionen über Schalter im Artikel oder in der Wand zu Schalten.
Choose different functions with switch in item or wall.
4 fonctions différentes par l'interrupteur sur le luminaire ou mural.



Inklusive Bewegungsmelder.
With motion detector.
Avec détecteur de mouvement.



Mit Schalter.
With switch.
Avec interrupteur.



Beinhaltet Batterien.
Incl. batteries.
Piles fournis.



Mit Zugschalter.
With pull switch.
Avec interrupteur à tirette.



Beinhaltet aufladbare Batterien.
Incl. rechargeable batteries.
Piles rechargeables fournis.



Berührungsschalter Ein - Aus.
With touch switch ON - OFF.
Au toucher, 2 fonctions : allumez ou éleairez.



Verstellbar mit Teleskopfunktion.
Adjustable with telescope function.
Réglage télescope.



Berührungsdimmer.
Touch dimmer
Gradateur sensitiv



Sehr große Abmessungen.
Very large dimensions.
Grande taille.



Stufenloser Dimmer.
Dimmer steplessly adjustable.
Avec variateur.



Artikel inklusive Energiesparleuchten.
These items are including energy saving bulbs.
Ampoules économie d'énergie fournies.



Inklusive AC/DC-Adapter.
Inclusive AC/DC-adaptor.
Adaptateur fourni.



ESTO empfiehlt Energiesparleuchtmittel zu verwenden.
We recommend to use energy saving bulbs.
Ampoules économiques non fournies recommandées.



Optional AC/DC-Adapter.
Optional AC/DC-adaptor.
Sur commande adaptateur.



Halogen energiesparend.
Energy saving halogen lamps.
Ampoules halogènes éco fournies.

SYMBOLERKLÄRUNG · DECLARATION OF SYMBOLS · DECLARATION SYMBOLE



LED inklusive.
LED included.
LED inclus.



LED dimmbar.
dimmable LED



LED tauschbar.
LED changeable
LED interchangeable



Einfach auswechselbare COB-LED.
Easy change COB-LED.



RGB-LED mit Farbwechsler inklusive.
RGB-LED with colour changer.
LED changement de couleurs inclus.



RGB-LED mit speziellen Farbtönen (pastell) inklusive.
RGB-LED with colour changer (pastel-colores).
LED changement de couleurs pastels inclus.



LED mit Farbwechsler inklusive.
LED with colour changer.
LED changement automatique de couleur.



Farben fixierbar.
Colours to fix.
Interrupteur de changement de couleur.



Inklusive Hochleistungs - LED.
High Power LED including.
LED high power fournis.



3 Watt High Power LED.
LED 3 watts high power fournis.



4 Watt High Power LED.
LED 4 watts high power fournis.



Leistungsdaten LED Panel.
Technical data LED panel.
Puissance LED en watts et en lumens.



Anzahl der LED Artikel.
Numbers of LED in item.
Nombre de LED inclus.



LED Panel mit hoher Lichtleistung und kleiner Bauform.
LED Panel with high light intensity and small construction.
Circuit imprimé LED haute luminosité.



Blendfreies Nachtlicht.
Dazzle-free night light.
Éclairage tamisé.



Sanfte und diffuse Lichtabgabe.
Soft and pleasant light.
Éclairage doux.



Schutzgrad
Degree of protection.
Classe de protection.



Solarartikel, Solarbetrieb.
Solar item, solar operation.
Éclairage solaire.

Allgemeine Liefer- und Zahlungsbedingungen der ESTO Lighting GmbH

1. Geltungsbereich

1.1 Diese allgemeinen Bedingungen gelten für alle Rechtsgeschäfte und zwar für die Lieferung von Waren aller Art.

1.2 Abweichungen von den Bedingungen sind nur bei schriftlicher Anerkennung durch den Verkäufer wirksam.

2. Angebot

2.1 Angebote des Verkäufers gelten als freibleibend.

2.2 Sämtliche Angebots- und Projektunterlagen dürfen ohne Zustimmung des Verkäufers nicht Dritten zugänglich gemacht werden. Sie können jederzeit zurückgefordert werden und sind dem Verkäufer unverzüglich zurückzustellen, wenn die Bestellung anderweitig erteilt wird.

3. Vertragsschluss

3.1 Der Vertrag gilt als geschlossen, wenn der Verkäufer nach Erhalt der Bestellung eine schriftliche Auftragsbestätigung oder eine Lieferung abgesandt hat.

3.2 Die in Katalogen, Prospekten u. dgl. enthaltenen Angaben können durch neue, der Weiterentwicklung der Produkte entsprechende Veränderung aufweisen.

3.3 Nachträgliche Änderungen und Ergänzungen des Vertrages bedürfen zu ihrer Gültigkeit der schriftlichen Bestätigung.

4. Preise

4.1 Die Preise gelten, wenn nicht anders vereinbart, ab Werk bzw. ab Lager des Verkäufers einschließlich Verpackung, Verladung und zuzüglich Umsatzsteuer. Wenn im Zusammenhang mit der Lieferung Gebühren, Steuern oder sonstige Abgaben erhoben werden, trägt diese der Käufer. Ist die Lieferung mit Zustellung vereinbart, so wird diese sowie eine allenfalls vom Käufer gewünschte Transportversicherung gesondert vereinbart, beinhaltet jedoch nicht das Abladen und Vertragen. Die Verpackung wird nur über ausdrückliche Vereinbarung zurückgenommen.

4.2 Bei einer vom Gesamtangebot abweichenden Bestellung behält sich der Verkäufer eine entsprechende Preisänderung vor.

5. Lieferung

5.1 Die Lieferfrist beginnt mit dem spätesten der nachstehenden Zeitpunkte:

- Datum der Auftragsbestätigung
- Datum der Erfüllung aller dem Käufer obliegenden technischen, kaufmännischen und sonstigen Voraussetzungen;
- Datum, an dem der Verkäufer eine vor Lieferung der Ware zu leistende Anzahlung oder Sicherheit erhält.

5.2 Der Verkäufer ist berechtigt, Teil- oder Vorlieferungen durchzuführen und zu verrechnen. Ist Lieferung auf Abruf vereinbart, so gilt die Ware spätestens 1 Jahr nach Bestellung als abgerufen.

5.3 Sofern unvorhersehbare oder vom Parteiwillen unabhängige Umstände, wie beispielsweise alle Fälle höherer Gewalt, eintreten, die die Einhaltung der vereinbarten Lieferfrist behindern, verlängert sich diese jedenfalls um die Dauer dieser Umstände; dazu zahlen insbesondere bewaffnete Auseinandersetzungen, behördliche Eingriffe und Verbote, Transport- und Verzollungs-Verzug, Transportschaden, Energie- und Rohstoffmangel und Arbeitskonflikte.

5.4 Falls zwischen den Vertragsparteien bei Vertragsabschluss eine Vertragsstrafe (Pönale) für Lieferverzug vereinbart wurde, wird diese nach folgender Regelung geleistet, wobei ein Abweichen von dieser in einzelnen Punkten ihre Anwendung im Übrigen unberührt lässt: Eine nachweislich durch alleiniges Verschulden des Verkäufers eingetretene Verzögerung in der Erfüllung berechtigt den Käufer, für jede vollendete Woche der Verspätung eine Vertragsstrafe von höchstens 1/2 %, insgesamt jedoch maximal 5 %, vom Wert der gegenständlichen Gesamtlieferung zu beanspruchen. Weitergehende Ansprüche aus dem Titel des Verzuges sind ausgeschlossen.

6. Bestellungen aus Deutschland (Speditions Klausel)

6.1 Waren werden nicht nach Deutschland importiert oder in eigener Verantwortung nach Deutschland geliefert. Deutsche Kunden beziehen Ware ab Werk/Lager in Österreich. Sofern wir den Weitertransport zum Kunden nach Deutschland übernehmen sollen, erfolgt dies auf dessen Risiko und Verantwortung des Kunden als bloße Speditionsleistung. Der Kunde ist dafür verantwortlich, die ggf. einschlägigen Vorschriften als Importeur/Einführer/Inverkehrbringer in den deutschen Wirtschaftsraum zu erfüllen (Information, Registrierung, Entsorgung u.ä.). Liefern wir nach Deutschland, erfolgt dies stets als bloße Speditionsleistung und nicht als Hersteller o.ä. Die mit der Auslieferung nach Deutschland

verbundenen Mehrkosten sind im jeweiligen Angebotspreis inkludiert, es erfolgt keine gesonderte Speditionsabrechnung. Sofern wir uns Drittunternehmen bedienen, dienen diese nur der Erfüllung unserer Pflichten als Spediteur.

7. Gefahrenübergang und Erfüllungsort

6.1 Nutzung und Gefahr gehen mit dem Abgang der Lieferung ab Werk bzw. ab Lager auf den Käufer über, und zwar unabhängig von der für die Lieferung vereinbarten Preisstellung (wie z.B. franko, CIF u.ä.).

8. Zahlung

8.1 Sofern keine Zahlungsbedingungen vereinbart wurden, ist die Rechnung 45 Tage ab Ausstellungsdatum zur Zahlung netto fällig. Unabhängig davon ist die in der Rechnung enthaltene Umsatzsteuer in jedem Fall bis spätestens 30 Tage nach Rechnungslegung zu bezahlen.

8.2 Bei Teilverrechnungen sind die entsprechenden Teilzahlungen mit Erhalt der jeweiligen Faktura fällig. Dies gilt auch für Verrechnungsbeträge, welche durch Nachlieferungen oder andere Vereinbarungen über die ursprüngliche Abschlusssumme hinaus entstehen, unabhängig von den für die Hauptlieferung vereinbarten Zahlungsbedingungen.

8.3 Zahlungen sind mit 2 % Skonto innerhalb 14 Tage - 45 Tage netto - frei Zahlstelle des Verkäufers in der vereinbarten Währung zu leisten. Eine allfällige Annahme von Scheck oder Wechsel erfolgt stets nur zahlungshalber. Alle damit im Zusammenhang stehenden Zinsen und Spesen (wie z.B. Einziehungs- und Diskontspesen) gehen zu Lasten des Käufers.

8.4 Der Käufer ist nicht berechtigt, wegen Gewährleistungsansprüchen oder sonstiger Gegenansprüche Zahlungen zurückzuhalten oder aufzurechnen.

8.5 Eine Zahlung gilt an dem Tag als geleistet, an dem der Verkäufer über sie verfügen kann.

8.6 Ist der Käufer mit einer vereinbarten Zahlung oder sonstigen Leistung aus diesem oder anderen Geschäften im Verzug, so kann der Verkäufer unbeschadet seiner sonstigen Rechte

a) die Erfüllung seiner eigenen Verpflichtungen bis zur Bewirkung dieser Zahlung oder sonstigen Leistung aufschieben und eine angemessene Verlängerung der Lieferfrist in Anspruch nehmen,

b) sämtliche offene Forderungen aus diesem oder anderen Geschäften fällig stellen und für diese Beträge ab der jeweiligen Fälligkeit Verzugszinsen in der Höhe von 1 % pro Monat verrechnen, sofern der Verkäufer nicht darüber hinausgehende Kosten nachweist. In jedem Fall ist der Verkäufer berechtigt vorprozessuale Kosten, insbesondere Mahnspesen und Rechtsanwaltskosten in Rechnung zu stellen.

8.7 Eingeräumte Rabatte oder Boni sind mit der termingerechten Leistung der vollständigen Zahlung bedingt.

8.8 Der Verkäufer behält sich das Eigentum an sämtlichen von ihm gelieferten Waren bis zur vollständigen Bezahlung der Rechnungsbeträge zuzüglich Zinsen und Kosten vor.

9. Gewährleistung und Entstehen für Mangel

9.1 Der Verkäufer ist bei Einhaltung der vereinbarten Zahlungsbedingungen verpflichtet, nach Maßgabe der folgenden Bestimmungen jeden die Funktionsfähigkeit beeinträchtigenden Mangel, der im Zeitpunkt der Übergabe besteht, zu beheben, der auf einem Fehler der Konstruktion, des Materials oder der Ausführung beruht. Aus Angaben in Katalogen, Prospekten, Werbeschriften und schriftlichen oder mündlichen Äußerungen, die nicht in den Vertrag aufgenommen worden sind, können keine Gewährleistungsansprüche abgeleitet werden.

9.2 Die Gewährleistungsfrist beträgt 12 Monate, soweit nicht für einzelne Liefergegenstände besondere Gewährleistungsfristen vereinbart sind.

8.3 Der Gewährleistungsanspruch setzt voraus, dass der Käufer die aufgetretenen Mängel unverzüglich schriftlich angezeigt hat. Der Käufer hat das Vorliegen des Mangels unverzüglich nachzuweisen, insbesondere die bei ihm vorhandenen Unterlagen bzw. Daten dem Verkäufer zur Verfügung zu stellen. Bei Vorliegen eines gewährleistungspflichtigen Mangels gemäß Punkt 9.1 hat der Verkäufer nach seiner Wahl am Erfüllungsort die mangelhafte Ware bzw. den mangelhaften Teil nachzubessern oder sich zwecks Nachbesserung zusenden zu lassen oder eine angemessene Preisminderung vorzunehmen.

9.4 Alle im Zusammenhang mit der Mangelbehebung entstehenden Nebenkosten (wie z.B. für Ein- und Ausbau, Transport, Entsorgung, Fahrt und Wegzeit) gehen zu Lasten des Käufers.

9.5 Von der Gewährleistung ausgeschlossen sind solche Mängel, die aus nicht vom Verkäufer bewirkter Anordnung und Montage, ungenügender Einrichtung,

Nichtbeachtung der Installationserfordernisse und Benutzungsbedingungen, Überbeanspruchung der Teile über die vom Verkäufer angegebene Leistung, nachlässiger oder unrichtiger Behandlung. Der Verkäufer haftet auch nicht für Beschädigungen, die auf Handlungen Dritter, auf atmosphärische Entladungen, Überspannungen und chemische Einflüsse zurückzuführen sind. Die Gewährleistung bezieht sich nicht auf den Ersatz von Teilen, die einem natürlichen Verschleiß unterliegen.

9.6 Ansprüche nach § 933b ABGB verjähren jedenfalls mit Ablauf der in Punkt 9.2 genannten Frist.

9.7 Die Bestimmungen 9.1 bis 9.7 gelten sinngemäß auch für jedes Entstehen für Mangel aus anderen Rechtsgründen.

10. Rücktritt vom Vertrag

10.1 Voraussetzung für den Rücktritt des Käufers vom Vertrag ist, sofern keine speziellere Regelung getroffen wurde, ein Lieferverzug, der auf grobes Verschulden des Verkäufers zurückzuführen ist sowie der erfolglose Ablauf einer gesetzten, angemessenen Nachfrist. Der Rücktritt ist mittels eingeschriebenen Briefes geltend zu machen.

10.2 Unabhängig von seinen sonstigen Rechten ist der Verkäufer berechtigt, vom Vertrag zurückzutreten,

a) wenn die Ausführung der Lieferung bzw. der Beginn oder die Weiterführung der Leistung aus Gründen, die der Käufer zu vertreten hat, unmöglich oder trotz Setzung einer angemessenen Nachfrist weiter verzögert wird,

b) wenn Bedenken hinsichtlich der Zahlungsfähigkeit des Käufers entstanden sind und dieser auf Begehren des Verkäufers weder Vorauszahlung leistet, noch vor Lieferung eine taugliche Sicherheit beibringt, oder

c) wenn die Verlängerung der Lieferzeit wegen der im Punkt 5.4 angeführten Umstände insgesamt mehr als die Hälfte der ursprünglich vereinbarten Lieferfrist betragt.

10.3 Der Rücktritt kann auch hinsichtlich eines noch offenen Teiles der Lieferung oder Leistung aus obigen Gründen erklärt werden.

10.4 Unbeschadet der Schadenersatzansprüche des Verkäufers einschließlich vorprozessualer Kosten sind im Falle des Rücktritts bereits erbrachte Leistungen oder Teilleistungen vertragsgemäß abzurechnen und zu bezahlen. Dies gilt auch, soweit die Lieferung oder Leistung vom Käufer noch nicht übernommen wurde sowie für vom Verkäufer erbrachte Vorbereitungshandlungen. Dem Verkäufer steht an Stelle dessen auch das Recht zu, die Rückstellung bereits gelieferter Gegenstände zu verlangen.

10.5 Sonstige Folgen des Rücktritts sind ausgeschlossen.

11. Haftung

11.1 Der Verkäufer haftet für Schaden außerhalb des Anwendungsbereiches des Produkthaftungsgesetzes nur, sofern ihm Vorsatz oder grobe Fahrlässigkeit nachgewiesen werden, im Rahmen der gesetzlichen Vorschriften. Die Haftung für

leichte Fahrlässigkeit, der Ersatz von Folgeschaden und Vermögensschaden, nicht erzielten Ersparnissen, Zinsverlusten und von Schaden aus Ansprüchen Dritter gegen den Käufer sind ausgeschlossen.

11.2 Sind Vertragsstrafen vereinbart, sind darüber hinausgehende Ansprüche aus dem jeweiligen Titel ausgeschlossen.

12. Geltendmachung von Ansprüchen

12.1 Sofern im Einzelfall nicht gesondert vereinbarte oder gesetzliche Bestimmungen kürzere Fristen vorsehen, sind alle Ansprüche des Käufers innerhalb von 3 Jahren ab Gefahrenübergang gerichtlich geltend zu machen, bei sonstigem Anspruchsverlust.

13. Gewerbliche Schutzrechte und Urheberrecht

13.1 Wird eine Ware vom Verkäufer auf Grund von Konstruktionsangaben, Zeichnungen, Modellen oder sonstigen Spezifikationen des Käufers angefertigt, hat der Käufer diesen bei allfälliger Verletzung von Schutzrechten schad- und klaglos zu halten.

13.2 Ausführungsunterlagen wie z.B. Plane, Skizzen und sonstige technische Unterlagen bleiben ebenso wie Muster, Kataloge, Prospekte, Abbildungen u. dgl. stets geistiges Eigentum des Verkäufers und unterliegen den einschlägigen gesetzlichen Bestimmungen hinsichtlich Vervielfältigung, Nachahmung, Wettbewerb usw. Punkt 2.2 gilt auch für Ausführungsunterlagen.

14. Allgemeines

14.1 Falls einzelne Bestimmungen des Vertrages oder dieser Bestimmungen unwirksam sein sollten, wird die Wirksamkeit der übrigen Bestimmungen nicht berührt. Die unwirksame Bestimmung ist durch eine gültige, die dem angestrebten Ziel möglichst nahe kommt, zu ersetzen.

15. Gerichtsstand und Recht

15.1 Zur Entscheidung aller aus dem Vertrag entstehenden Streitigkeiten - einschließlich solcher über sein Bestehen oder Nichtbestehen - ist das sachlich zuständige Gericht am Hauptsitz des Verkäufers ausschließlich zuständig. Der Vertrag unterliegt österreichischem Recht unter Ausschluss der Weiterweisungsnormen. Die Anwendung des UNCITRAL-Übereinkommens der Vereinten Nationen über Verträge über den internationalen Warenkauf wird ausgeschlossen.

ESTO-Lighting GmbH, 9220 Velden/Lind, Jessenigstraße 2, Telefon +43 (0)4274 31330, Fax: +43 (0)4274 51359

Alle Maßangaben in mm.

Die im Katalog abgebildeten Produkte können durch das Druckverfahren im Farbton leicht vom Originalton abweichen. Wir liefern aufgrund unserer Liefer- und Zahlungsbedingungen. Technisch bedingte Änderungen der Materialien, Maße oder Farben behalten wir uns vor.

All dimensions in mm

Due to the printing process, the products depicted in the catalogue may vary slightly in shade from the original colours. We deliver according to our delivery and payment conditions. We reserve the right to change the materials, measurements or colours slightly if determined by technical reasons.

Toutes les dimensions sont en mm.

L'impression peut faire légèrement varier la couleur des produits représentés dans le catalogue de leur couleur originale. Livraison et facturation selon nos conditions générales de vente. Nous nous réservons le droit, d'apporter sans préavis des modifications dans la spécification des articles figurant dans notre catalogue.

Tutti dimensioni in mm

Ci riserviamo cambiamenti a causa della tecnologia, del materiale, forme, misure o tonalità cromatica.

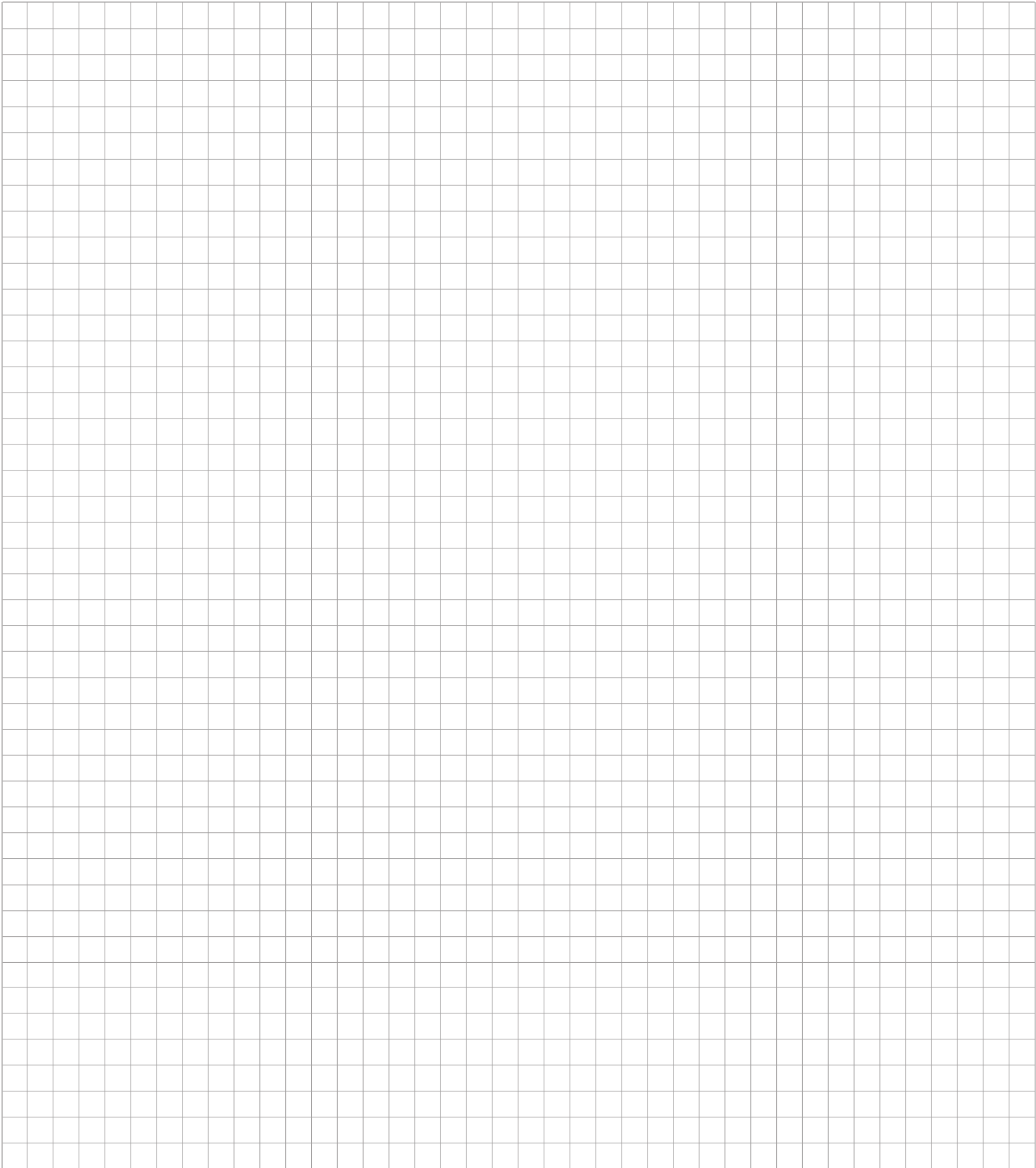

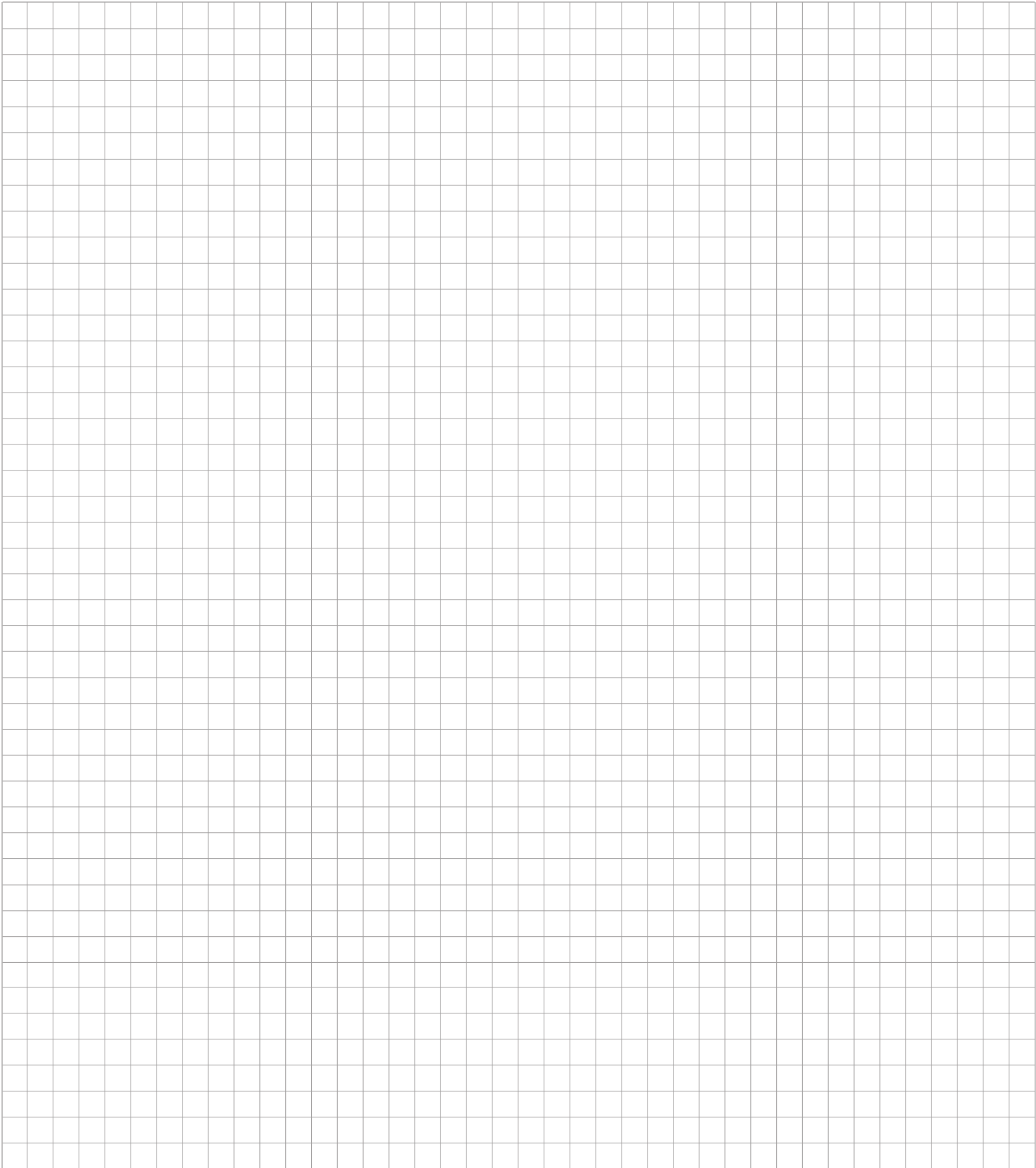





www.esto.at, e-mail: office@esto.at
ESTO Lighting GmbH • 9220 Velden / Lind • Jessenigstraße 2 • AUSTRIA
Tel. +43 / (0) 4274 / 3133-0 • Fax +43 / (0) 4274 / 51359